

Four Winds

INTERNATIONAL



OWNER'S MANUAL

PRINT DATE 07/2007

TABLE OF CONTENTS

FOUR WINDS INTERNATIONAL LIMITED WARRANTY

WHAT IS COVERED	1
LIMITATIONS AND DISCLAIMER OF IMPLIED WARRANTIES	1
LIMITED STRUCTURAL WARRANTY (36 MONTH/45,000 MILES)	2
HOW TO GET SERVICE	2
WHAT IS NOT COVERED	3
LEGAL REMEDIES/ARBITRATION	4
FOUR WINDS INTERNATIONAL OWNER'S REGISTRATION CARD (CUSTOMER COPY)	5
FOUR WINDS INTERNATIONAL OWNER'S REGISTRATION CARD	7

GENERAL INFORMATION

INTRODUCTION	1-1
DISCLAIMER	1-2
MANUFACTURER'S WARRANTIES	1-3

IDENTIFICATION & SAFETY

SYMBOLS	2-1
REPORTING SAFETY DEFECTS	2-1
LAWS OF THE ROAD	2-2
RECREATION VEHICLE SERIAL NUMBER DECAL & DATA PLATES	2-2
SAFETY REGULATIONS FOR PROPANE GAS SYSTEMS & APPLIANCES	2-3
FIRE SAFETY	2-4
FIRE EXTINGUISHER	2-5
CARBON MONOXIDE & SMOKE DETECTOR	2-6
Programming the Alarm	2-6
Testing Procedure	2-7
Carbon Monoxide Safety Precautions	2-8
PROPANE GAS DETECTOR	2-9
Maintenance	2-9
How to Test	2-10
Checking the Propane Gas System for Leaks	2-10
About the Propane Gas Detector	2-11
Most Common Causes of Apparent Malfunction	2-11
Propane Safety Precautions	2-12
CHEMICAL SENSITIVITY	2-13
Formaldehyde	2-13
Ventilation	2-13
SEAT BELTS	2-14
Seat Belt Operation	2-14
Maintenance	2-14
Child Restraints	2-15
Booster Seats	2-15
EGRESS WINDOW	2-16

CHASSIS OPERATIONS & PROCEDURES

BRAKES	3-1
TIRES	3-2
Finding the Recommended Tire Pressure & Load Limits	3-2
Understanding Tire Pressure & Load Limits	3-2
Checking Tire Pressure	3-3
Tire Size	3-3
Tire Tread	3-4
Tire Balance & Wheel Alignment	3-4
Tire Rotation	3-5
Tire Repair/Replacement	3-6
Wheel Nut Torque	3-6
Tire Fundamentals	3-7
U.S. DOT Tire Identification Number	3-7
RECREATION VEHICLE LOAD LIMITS	3-7
Weight Terms	3-8
Weight Label (Example)	3-8
Cargo Capacities	3-9
How Overloading Affects the Recreation Vehicle & Tires	3-9
Tire Safety Tips	3-10
Determining Correct Load Limit	3-10
SPARE TIRE	3-11
Spare Tire Hoist	3-11
Spare Tire Flip Down Style Carrier	3-12
TRAILER TOWING	3-13
TOWING PROCEDURES	3-14
EMERGENCY STOPPING	3-15
ENGINE & DRIVE TRAIN	3-15
Engine Cooling System	3-15
Engine Access	3-16
FUELING THE RECREATION VEHICLE	3-16
Ford Fuel Pump Collision Shut-off Switch	3-16
TRAVEL PREPARATION	3-17
Chassis Checks	3-17
Exterior Checks	3-17
Undercarriage Checks	3-17
Operational Checks	3-17
Pre-Trip Checklist	3-18
First Short Trips	3-18

INTERIOR CONTROLS & OPERATIONS

DASH CONTROLS	4-1
Mirror Control Button	4-1
Mirror Heat	4-1
ACC (Accessory) Switch	4-1
Driving Lights	4-1
Emergency Start (Optional)	4-1
Generator Remote Start (Optional)	4-2
Fans (Optional)	4-2
DASH RADIO	4-2
REAR VISION SYSTEM	4-3
AUTOMATIC HYDRAULIC POWER LEVELERS	4-4
Automatic Leveling & Retraction Procedure	4-5
Manual Leveling & Retraction Procedures	4-6
Emergency Retraction Procedure	4-7
SLIDEOUTS	4-9
Hydraulic Slideout	4-9
Hydraulic Slideout - Manual Room Retraction Procedure	4-10
Non-Hydraulic Slideout	4-12
Non-Hydraulic Slideout - Manual Room Retraction Procedure	4-13
WINDOWS	4-14
DOORS, DRAWERS & STORAGE COMPARTMENTS	4-14
Bed Storage (Some Models)	4-14
FURNITURE	4-15
Easy Bed Sofa with Drawer	4-15
Magic Bed Sofa	4-16
Hide-A-Bed Sofa	4-16
Barrel Chair	4-17
Euro Recline with Ottoman	4-17
Dinette	4-17
Lounge Table	4-17
Pilot & Co-Pilot Seats	4-18

EXTERIOR CONTROLS & OPERATIONS

ENTRY DOOR	5-1
ENTRY STEP	5-1
Power Entry Step	5-2
STORAGE COMPARTMENTS	5-3
REAR LADDER/ROOF ACCESS	5-3
AWNINGS	5-4
Slideout Awning	5-4
Manual Patio Awning	5-4
Automatic Patio Awning	5-5
GARAGE AREA (FUN MOVER)	5-6
Liftgate	5-7
Fold-Down Ramp	5-7
Core-Trax™ Tie-Down System	5-8

HEATING & AIR CONDITIONING

DASH PANEL HEATER/AIR CONDITIONER	6-1
Control Panel	6-1
Operating Features	6-2
Air Distribution - Mode Control	6-2
Warranty/Service	6-3
ROOF MOUNTED AIR CONDITIONERS	6-3
Performance Characteristics	6-3
Return Air Filters	6-4
FURNACE	6-4
THERMOSTATS	6-5
CEILING VENTS	6-5
Exhaust Vent	6-5
Attic Fan	6-6

ELECTRICAL SYSTEMS

SHORE CORD	7-2
30 Amp Shore Power	7-2
50 Amp Shore Power	7-3
BATTERIES	7-3
Battery Safety	7-4
Battery Maintenance	7-4
Battery Isolator Controller (Class A Recreation Vehicles - Not Available on all Models)	7-6
Battery Isolator Controller (Class C Mini Recreation Vehicles)	7-7
Battery Disconnect Switch	7-7
Battery Charging	7-8
POWER CONVERTER	7-8
POWER INVERTER (OPTIONAL)	7-9
GROUND FAULT CIRCUIT INTERRUPTER	7-10
CIRCUIT BREAKERS	7-11
12 VOLT SYSTEM FUSES	7-11
Interior	7-11
Automotive	7-11
CHASSIS ALTERNATOR	7-12
GENERATOR	7-13

WATER SYSTEMS

FRESH WATER SYSTEM	8-1
External Hook-up	8-1
Fresh Water Tank With Gravity Fill	8-2
Fresh Water Tank Without Gravity Fill	8-2
Water Pump	8-3
Sanitizing the Fresh Water System	8-4
MONITOR PANEL	8-5
Troubleshooting	8-5
Inaccurate Holding Tank Level Readings	8-6
Oversensitive Readings	8-6
Undersensitive Readings	8-7
Technical Support	8-7
WASTE WATER SYSTEM	8-7
Holding Tanks	8-8
Emptying the Holding Tanks	8-9
Toilet	8-10
WATER SYSTEM WINTERIZATION	8-11
Class A, Kodiak & 750 Fun Mover Water System Winterization	8-11
Class C Water System Winterization	8-12
WATER SYSTEM MAINTENANCE & TROUBLESHOOTING	8-12

PROPANE GAS SYSTEMS

PROPANE GAS TANK	9-1
Filling the Propane Gas Tank	9-2
PROPANE GAS REGULATOR	9-3
Regulator Freeze-Up	9-4
PROPANE GAS HOSES, PIPES, TUBES & FITTINGS	9-5
PROPANE GAS DETECTOR	9-6
Maintenance	9-6
How to Test	9-7
Checking the Propane Gas System for Leaks	9-7
About the Propane Gas Detector	9-8
Most Common Causes of Apparent Malfunction	9-8
PROPANE GAS SAFETY PRECAUTIONS	9-9

CARE & MAINTENANCE

FIBERGLASS SIDING	10-1
EXTERIOR PAINT (OPTIONAL)	10-2
Pressure Washing	10-2
Precautionary Measures	10-2
SEALS AND ADHESIVES	10-3
FRAME	10-3
TIRES & RIMS	10-4
ROOF	10-4
EXTRUSIONS & ALUMINUM SURFACES	10-4
WINDOWS & DOORS	10-5
PROPANE GAS SYSTEM	10-5
DRAINAGE SYSTEM	10-6
TV ANTENNA	10-6
EXTERIOR LIGHTS	10-7
Headlamp Condensation	10-7
Headlamp Maintenance	10-7
Headlamp Bulb Replacement	10-8
SINKS & COUNTERTOPS	10-8
APPLIANCES	10-9
Propane Gas Appliances & Equipment	10-9
PRE-FINISHED PANELS & WOOD SURFACES	10-9
WATER SYSTEM	10-9
ELECTRICAL SYSTEM	10-10
ROOF VENTS	10-10
ABS PLASTIC	10-10
WINTER PRECAUTIONS	10-10
Water System	10-10
Food Storage	10-11
Propane Gas System	10-11
Heating	10-11
Condensation	10-11
STORAGE PREPARATION	10-12
MOLD	10-13
What Factors Contribute to Mold Growth?	10-13
How can Mold Growth be Inhibited?	10-13
Effects of Prolonged Occupancy	10-14
Tips to Controlling Condensation	10-14
Avoid Drastic Thermostat Setbacks	10-15
Carpet Care & Moisture Management	10-15
Exterior Care of the Recreation Vehicle	10-15
Storage of the Recreation Vehicle	10-16
PERIODIC	10-17

INDEX

Index	11-1
-------------	------

FOUR WINDS INTERNATIONAL LIMITED WARRANTY

What is Covered

Four Winds International Corporation (hereafter Four Winds), warranty shall be applicable to the recreation vehicles (hereafter RV), when used only for recreational travel and camping, for one (1) year or the first fifteen thousand (15,000) miles of use, whichever occurs first. The warranty period begins on the date that the RV is delivered to the first retail owner by an independent, authorized Four Winds dealer. In the event that a substantial defect in material or workmanship, attributable to Four Winds, is found to exist during the warranty period, Four Winds will repair or replace the defective material or workmanship, at its option, at no charge to the RV owner, in accordance with the terms, conditions and limitations of this Limited Warranty.

This Limited Warranty only applies to the first retail owner of the RV. All rights and limitations within this warranty are applicable to first retail owner, and all owners must complete the Warranty Registration Form contained in the Owner's Manual and send it to Four Winds.

Four Winds' obligation to repair or replace defective materials or workmanship is the sole obligation of Four Winds under this Limited Warranty. Four Winds reserves the right to use new or remanufactured parts of similar quality to complete any work. The RV owner's obligation to notify Four Winds, or one of its authorized, independent dealers, of a claimed defect does not modify any obligation placed on the RV owner to contact Four Winds directly when attempting to pursue remedies under state or federal law.

Limitations and Disclaimer of Implied Warranties

The following limitations and disclaimers apply to the original purchaser of the RV, any person to whom the RV is transferred and any person who is an intended or unintended user or beneficiary of the RV. **ANY IMPLIED WARRANTY ARISING BY WAY OF STATE OR FEDERAL LAW, INCLUDING ANY IMPLIED WARRANTY OF MERCHANTABILITY OR ANY IMPLIED WARRANTY OF FITNESS, ARE LIMITED IN DURATION TO THE LENGTH OF THIS LIMITED WARRANTY AND ARE LIMITED IN SCOPE OF COVERAGE TO THOSE PORTIONS OF THE MOTORHOME COVERED BY THIS LIMITED WARRANTY. PERFORMANCE OF REPAIRS OR NEEDED ADJUSTMENTS IS THE EXCLUSIVE REMEDY UNDER THIS LIMITED WARRANTY OR ANY IMPLIED WARRANTY.** Four Winds makes no warranty of any nature beyond that contained in this Limited Warranty. No one has the authority to enlarge, amend or modify this Limited Warranty. The dealer is not Four Winds' agent, but is an independent entity.

In addition, Four Winds **SHALL NOT BE LIABLE FOR ANY INCIDENTAL OR CONSEQUENTIAL DAMAGES THAT MAY RESULT FROM BREACH OF THIS LIMITED WARRANTY OR ANY IMPLIED WARRANTY. THIS EXCLUSION OF CONSEQUENTIAL AND INCIDENTAL DAMAGES SHALL BE INDEPENDENT OF ANY FAILURE OF THE ESSENTIAL PURPOSE OF ANY LIMITED WARRANTY, AND THIS EXCLUSION SHALL SURVIVE ANY DETERMINATION THAT THIS LIMITED WARRANTY OR ANY IMPLIED WARRANTY HAS FAILED OF ITS ESSENTIAL PURPOSE.**

Some states do not allow limitations on how long an implied warranty lasts, or the exclusion or limitations of incidental or consequential damages. Therefore, the above limitations may not apply to you.

Limited Structural Warranty (36 Months/45,000 Miles)

In addition to the above terms and conditions, Four Winds International Corporation warrants to the first retail owner purchased from an authorized dealer that the structural components of your RV will be free of substantial defects in material and workmanship for a period of thirty-six (36) months from the date of retail purchase or for the first 45,000 miles of usage, whichever occurs first.

For the purpose of this warranty, “steel or aluminum structural components” shall be limited to the structure of the sidewalls, front and back wall, roof, and floor.

Damaged caused by misuse, abuse, collision, alteration, failure to properly maintain the exterior sealants, cosmetic defects, improper repairs, discoloration, and normal deterioration is not covered by this 36 month/45,000 mile limited structural warranty. Maintenance such as periodic resealing of the windows, molding, doors, vents, awnings, and other exterior-mounted components, and damage caused by the failure to adhere to the prescribed maintenance chart in this manual is excluded from this coverage.

How to Get Service

To obtain warranty service the owner must do all of the following:

1. Complete and return the Owner Registration Card within ten (10) days of purchase;
2. Notify Four Winds, or one of its authorized, independent dealers, in writing, of any claimed defect within the warranty coverage period;
3. Provide the notification mentioned in (2), above, within ten (10) days of discovery of the defect; and
4. Promptly return the RV to an authorized dealer for repairs.

For warranty service; contact one of Four Winds’ independent, authorized service centers for an appointment and then deliver your RV to the service center on the specified appointment date. If you need assistance contact Four Winds at:

Four Winds International Corporation
PO Box 1486, Elkhart, Indiana 46515
(574) 266-1111 • Fax: (574) 294-3618 • Website: www.fourwinds-rv.com

If two (2) or more service attempts have been made to correct any covered defect that you believe impairs the value, use or safety of the RV, you must, to the extent permitted by law, notify Four Winds directly, in writing, of the unsuccessful repair of the alleged defect so that Four Winds can become directly involved in making sure that you are provided service pursuant to the terms of this limited warranty.

Because Four Winds does not control the scheduling of service work at any service center you may encounter delays in scheduling and/or the completion of work. All costs associated with transporting the RV for any warranty service shall be the sole responsibility of the RV owner.

What is Not Covered

This Limited Warranty does not cover any material, component or part of the RV that is warranted by another entity, including, by way of example, but not limited to; the automotive chassis and power train, including the engine, drive train, steering and alignment, handling and alignment, braking, wheel balance, muffler, tires, tubes, batteries and gauges, generator, hydraulic jacks, inverter, range, carbon monoxide detector, furnace, roof air conditioner, refrigerator, audio/video equipment and microwave.

Minor adjustments such as adjustments to the interior or exterior doors, drawers, latches, etc. will be performed by the dealer during the first 90 days of warranty coverage. Thereafter, such adjustments are the owners' responsibility as normal maintenance.

In addition, by way of example only, this Limited Warranty does not cover any of the following: items that are added or changed after the Motorhome leaves Four Winds; any RV used for rental or other commercial purposes (Note: It shall be assumed the RV has been used for rental or business purposes if the RV is purchased or registered in a company name, or if the RV owner claims a tax benefit on a tax form); normal wear, tear or usage, such as fading or discoloration of fabrics or the effects of condensation inside the RV; items that are working as designed but that you are unhappy with because of the design; problems related to misuse, including failure to maintain RV in accordance with the owner's manual, or failure to perform other routine maintenance; damage due to accident whether or not foreseeable, including any acts of weather or damage or corrosion due to environment, rust, theft, vandalism, fire, or other intervening acts not attributable to Four Winds; cost related to transportation, towing or damage as a result of towing, lodging, loss or damage to personal property, loss of owner's product, inconvenience, loss of income, rental vehicles; glass breakage; damage from misuse of equipment used for purposes other than intended design; damage resulting from tire wear or tire failure; defacing, scratches, dents, chips on any surface or fabric of the RV; damage caused by off road use, overloading the RV or alteration of the RV, or any of its components, parts or electrical systems. Parts and labor for expendable service maintenance items including, but not limited to, wiper blades, bulbs, fluids and filters are excluded from warranty coverage.

It is the owner's responsibility to take any necessary preventative maintenance measures, as described in the care and maintenance section of the Four Winds International owners' manual including periodic maintenance of exterior caulking and sealers. It is the responsibility of the owner to take necessary measures to prevent secondary damage from rainwater, plumbing leaks, condensation, and the natural accumulation of moisture in your recreation vehicle. Failure to do so may result in stains, damage, separation, and formation of mold to the floor, walls, upholstery, carpeting, furniture, drapes and other components. Mold is a natural growth given certain environmental conditions and is not covered by the terms and conditions of the Four Winds International Limited Warranty.

Chemical off-gassing is not a "defect" in the RV and is not covered by the term and conditions of the Four Winds International Limited Warranty. Please refer to the Safety Section (Section 2 Page 12) of this manual for additional information.

Legal Remedies/Arbitration

Four Winds International Corporation participates in the Consumer Arbitration Program for Recreation Vehicles (CAP-RV). This third-party dispute resolution program is available, at no charge to you, to settle unresolved warranty disputes for recreation vehicles. This dispute resolution program reviews eligible product and service related complaints involving warranty covered components.

To find out more about the program, or to request an application/brochure, please call the Arbitration Administration office toll-free (800) 279-5343.

For recreation vehicles purchased in the State of California: The CAP-RV program operates as a certified mechanism under the review of the California Arbitration Certification Program. You must utilize the arbitration program before claiming rights conferred by 15 USC section 2310 (Uniform Commercial Code) or Civil Code section 1793.22(b) (Song-Beverly Warranty Act). You are not required to use the program if you choose to seek redress by pursuing rights and remedies not created by those laws.

Any action to enforce any portion of this express, Limited Warranty, or any implied warranty, shall be commenced within one (1) year after expiration of the warranty coverage period designated above or as required by law. Any performance of repairs shall not suspend this one-year limitation period from expiring. Any performance of repairs after the warranty coverage period has expired, or performance of repairs regarding any thing excluded from coverage under this Limited Warranty, shall be considered good will repairs, and they will not alter the express terms of this Limited Warranty, or extend the warranty coverage period or this limitation period. In addition, this warranty is not intended to extend to future performance, and nothing in this warranty, or any action of Four Winds, shall be interpreted as an extension of the warranty or this limitation period.

THIS WARRANTY GIVES YOU SPECIFIC LEGAL RIGHTS. YOU MAY HAVE OTHER RIGHTS THAT VARY FROM STATE TO STATE.

Four Winds International Corporation
PO Box 1486, Elkhart, Indiana 46515
(574) 266-1111 • Fax: (574) 294-3618 • Website: www.fourwinds-rv.com

07/2007 TC

FOUR WINDS OWNER'S REGISTRATION CARD (CUSTOMER COPY)

This page is to be completed by the selling dealer and is to be kept in your Four Winds International recreational vehicle for reference if warranty service is required.

FOUR WINDS OWNER REGISTRATION CARD			
Date of Purchase	Four Winds Serial Number	Model	Year
Chassis Serial Number	Chassis Manufacturer	Mileage	
OWNER Mr. <input type="checkbox"/> Mrs. <input type="checkbox"/> Ms. <input type="checkbox"/>		DEALER	
Owner's Name (Last, First Middle)		Selling Dealer	
Address (Street or P.O. Box)		Address (Street or P.O. Box)	
City	State	City	State
	Zip		Zip
Telephone	Cell Phone	Telephone	
E-mail			

FOUR WINDS OWNER'S REGISTRATION CARD

Complete this Product Registration Card with the selling dealer and return within ten (10) days of the purchase.

ACKNOWLEDGEMENT OF RECEIPT OF WARRANTY/PRODUCT REGISTRATION			
Date of Purchase	Four Winds Serial Number	Model	Year
Chassis Serial Number	Chassis Manufacturer	Mileage	
OWNER Mr. <input type="checkbox"/> Mrs. <input type="checkbox"/> Ms. <input type="checkbox"/>		DEALER	
Owner's Name (Last, First Middle)		Selling Dealer	
Address (Street or P.O. Box)		Address (Street or P.O. Box)	
City	State	City	State
	Zip		Zip
Telephone	Cell Phone	Telephone	
E-mail		Please type or print and mail this form within 10 (ten) days of purchase to: FOUR WINDS INTERNATIONAL CORPORATION P.O. Box 1486 Elkhart, Indiana 46515 Phone: 574-266-1111 Fax: 574-294-3618	
Owner's Signature (MUST BE SIGNED)			

The failure to complete and return this product registration card does not diminish your warranty rights.



Acknowledgement of Receipt of Warranty/Product Information

IMPORTANT: The customer is required to read this document before signing it.

We have listed several items which will help acquaint you with your new recreation vehicle. You the purchaser, should not submit this form until (1) you have received and reviewed the Limited Warranty and owner's manual; (2) you have had the opportunity to inspect and operate the vehicle; (3) all items have been demonstrated and/or explained to you; (4) the dealer has answered any questions you may have, and; (5) you find the vehicle in good condition. The dealer is not authorized to deliver this vehicle until this has been done and both you and the dealer have signed this form.

Serial Number:		VIN Number:	
Owner's Last Name:	<input style="width:300px;" type="text"/>	First:	<input style="width:150px;" type="text"/>
Address:	<input style="width:500px;" type="text"/>		
	<input style="width:500px;" type="text"/>		
	<input style="width:500px;" type="text"/>		
City:	<input style="width:150px;" type="text"/>	State:	<input style="width:100px;" type="text"/>
		Zip:	<input style="width:100px;" type="text"/>
Country:	<input style="width:150px;" type="text"/>	Phone:	<input style="width:150px;" type="text"/>
Owner's E-mail:	<input style="width:300px;" type="text"/>	Retail Delivery Date:	<input style="width:100px;" type="text"/>

Owner/Dealer Inspection

- | | |
|--|--|
| <ol style="list-style-type: none"> 1. Exterior and interior finish 2. Operate all appliances (electrical and gas) <ol style="list-style-type: none"> a. Furnace and thermostat (lighting and maintenance) b. Range and oven (lighting and maintenance) c. Water heater (lighting and maintenance) d. Refrigerator (operation and maintenance) 3. Review operation of manual or automatic Propane Gas regulator 4. Operate plumbing facilities including water faucet's, shower and toilet | <ol style="list-style-type: none"> 5. Operate all doors and windows including locks 6. Observe or check to assure that all wheel lugs are tight and tire pressure is correct. 7. Operate 120 Volt generator (if so equipped) 8. Operate all air conditioners, radio, entertainment system and televisions (if so equipped) 9. Complete review of owner's manual by dealer with owner. 10. Test drive. 11. Odometer reading as observed by customer is: <input style="width:100px;" type="text"/> Miles <input style="width:100px;" type="text"/> Kilometers |
|--|--|

I have completed the above inspection on this recreation vehicle and have taken the test drive at the time of purchase. I noted:

I received and read a copy of the Four Winds International Limited Warranty and the Chassis Limited Warranty before I purchased the vehicle and agreed to the terms and conditions therein. I understand that it is to be used only for travel on improved roads. I also understand that the selling dealer is not an agent for Four Winds International but is an independent company with no authority to make any representation or promise for Four Winds International.

I acknowledge that the chassis, component parts and appliances that are separately covered by another manufacturer's warranty are excluded from coverage under the Four Winds International Limited Warranty. I understand that this form is for product registration purposes and failure to return this form does not diminish my warranty rights during the warranty period.

Purchaser Signature	Date	Dealer Signature	Date
---------------------	------	------------------	------

The Purchaser has: inspected, or been given the opportunity to inspect the vehicle; taken the test drive; supplied the information about his/her name and address; been given the opportunity to make notations in the space provided; observed, or received satisfactory explanations about, all items listed above.

Salesperson First Name:	Last Name:	Sales Split	Salesperson E-mail:
<input style="width:150px;" type="text"/>	<input style="width:150px;" type="text"/>	<input style="width:100px;" type="text"/>	<input style="width:150px;" type="text"/>
Selling Dealer:		Date:	Transaction Price:
<input style="width:400px;" type="text"/>		<input style="width:100px;" type="text"/>	<input style="width:100px;" type="text"/>

Dealer is to assure this form is properly completed and returned to Four Winds International within fifteen (15) days after delivery.
Return this page to: Four Winds International, P.O. Box 1486, Elkhart, Indiana 46515 • Fax 574-294-3618

GENERAL INFORMATION

INTRODUCTION

Thank you for choosing a Four Winds International Corporation product.

We take your choice seriously. That's why we have engineered this recreational vehicle to meet and in many cases exceed federal and state regulations and requirements for vehicles of this type. It is our goal to provide you, the customer, with a recreation vehicle that is not only pleasing to the eye, but safe and dependable as well.

With safety in mind, Four Winds highly recommends that you read this manual, as well as the chassis manufacturer's operation manual, prior to operating the recreation vehicle. Always keep these manuals with the recreation vehicle for easy reference.

Be sure to read all warranty and registration information carefully, including the warranties and operation manuals for individual components. Validate any individual component warranties by completing and mailing their respective warranty cards as required.

NOTE: *Complete the Warranty Registration Card in this manual and return the card to Four Winds within 10 days from the date of purchase.*

The recreation vehicle is thoroughly inspected prior to shipment to the dealer. However, to insure your complete satisfaction, the dealer must also perform an inspection of the various components and operations based on a pre-delivery inspection list. Take this opportunity to cover the operation of all components of the recreation vehicle with the dealer. This will help familiarize you with the recreation vehicle; as well as assure you that the recreation vehicle is in excellent working condition.

A road test by the dealer should be included as part of the pre-delivery inspection. During the road test the dealer should check for and correct any steering problems before you take delivery of the recreation vehicle. After this road test has been completed, front end alignment and/or vibrations will not be covered as part of the Limited Warranty.

This recreation vehicle has been designed for short term recreational use and is not intended to be used as a permanent dwelling, or as a rental vehicle. If you intend to use the recreation vehicle as a permanent dwelling or rental vehicle, it could cause premature deterioration of, but not limited to, the carpet, drapes, upholstery, and interior surfaces. This premature wear caused by long term or permanent residency may, under the terms of the Limited Warranty, could be considered abnormal and abusive and could reduce your warranty coverage.

Should a problem arise for which you need assistance, contact your dealer. If the problem is automotive in nature, the recreation vehicle should be taken either to a chassis manufacturer service center or automotive chassis dealer. If the problem is with an appliance, check the appliance manufactures information supplied with the recreation vehicle for information regarding warranty work and/or location of appliance service centers.

If you experience a breakdown or problem while the recreation vehicle is under warranty, and an authorized service center or dealer is not available, if possible, contact the dealer you purchased the recreation vehicle from, or a Four Winds Technical Service Advisor at (574) 266-1111 before having any service work performed. By notifying Four Winds, you will be aware of what is covered under the terms of the Limited Warranty, as well as informing Four Winds of your problem.

NOTE: *Any parts that require replacement, that are covered under the terms of the warranty must be retained and returned to your dealer along with your invoice. This way, they are able to check what has occurred, and also make sure you are properly reimbursed.*

Repairs made without prior authorization may be subject to denial or partial reimbursement. Modifications made to the recreation vehicle without proper authorization can result in reduction or loss of Limited Warranty coverage. Please make sure to contact your dealer before making such changes.

DISCLAIMER

The following information reflects product design, fabrication, and component parts at the time of printing. Four Winds International Corporation reserves the right, at anytime, to make changes in product design, material or component specifications at its sole option without notice. This includes the substitution of components of different brand or manufacturer name, which results in comparable performance.

Your actual RV may vary from this document as a result of optional equipment offered on this model and year of RV. In the case that you are not the initial retail owner of this unit, this document will not reflect modifications that may have been performed by previous owners. Photographs, line art, and diagrams contained herein may reflect both standard and optional equipment at the time of printing.

All information printed in this document is subject to change after the date of printing. As a result of product improvements, changes during model year production and/or transcription errors that may occur, information represented within the owner's manual and/or this document may not be the most current information available at the time of purchase. Please consult with your independent Four Winds dealer to confirm this information.

MANUFACTURER'S WARRANTIES

The following list of components has been compiled to help you know which products on your recreation vehicle may have their own warranties. If you have any of these components on your recreation vehicle, be sure to check the literature supplied by the manufacturer to see if they require that you register your purchase with them to validate their warranty. We recommend that you send the various warranty registration cards immediately before any time constraints on registration expire. Manufacturer's literature is contained in a separate packet furnished with the owner's manual on newly delivered units. Only those products and options which are on your recreation vehicle will be included in this packet. You should go over this literature with your dealer during the pre-delivery inspection. Any shortages of literature should be reported to the dealer at that time.

APPLIANCES		
Air Conditioner (Roof)	Home Theater System	Satellite System
Awnings	Ice Maker	Television Antenna
Back-up Monitor	Microwave Oven	Television Switchbox
Central Vacuum	Radios	Televisions
DVD Player	Range & Cooktop	
Fireplace	Refrigerator	
Furnace	Roof Vents	

ELECTRICAL		
Battery	Generator	Propane Gas Leak Detector
Converter	GFCI Recepts	Smoke/CO Detector
Electric Entry Step	Inverter	

WATER & DRAINAGE		
Toilet	Water Faucets	Water Heater
Washer/Dryer Combo	Water Filter	Water Pump

PROPANE		
Propane Gas Tank	Regulator	

CHASSIS		
Air Conditioner	Cruise Control	
Batteries	Leveling Jacks	

IDENTIFICATION & SAFETY

SYMBOLS

The following safety alert symbols are used throughout this manual to call attention to warnings where possible personal injury or vehicle damage may be involved.

DANGER

DANGER indicates an imminently hazardous situation which, if not avoided, will result in death or serious injury.

WARNING

WARNING indicates a potential hazardous situation which, if not avoided, could result in death or serious injury.

CAUTION

CAUTION indicates a potentially hazardous situation which, if not avoided, may result in minor or moderate injury.

NOTICE

NOTICE indicates a potentially hazardous situation which, if not avoided, may result in property damage.

REPORTING SAFETY DEFECTS

If you believe that your recreation vehicle has a defect which could cause a crash or could cause injury or death, you should immediately inform the National Highway Traffic Safety Administration (NHTSA) in addition to notifying Four Winds International.

If NHTSA receives similar complaints, it may open an investigation, and if it finds that a safety defect exists in a group of vehicles, it may order a recall and remedy campaign. However, NHTSA cannot become involved in individual problems between you, your dealer, or Four Winds International.

To contact NHTSA, you may either call the Auto Safety Hotline toll-free at 1-888-327-4236 (TTY: 1-800-424-9153); go to <http://www.safecar.gov>; or write to: Administrator, NHTSA, 400 Seventh St. S.W., Washington, DC 20590. You can also obtain other information about motor vehicle safety from <http://www.safecar.gov>.

LAWS OF THE ROAD

It is advisable to contact the Department of Motor Vehicles in each respective state, for up-to-date information regarding operation and licensing requirements for your particular recreation vehicle.

The state of California currently requires operators of recreation vehicles over 40 feet in length to obtain a non-commercial class B license. California has also enacted legislation limiting use of recreation vehicles in excess of 40 feet, to approved roadways. You may contact Caltrans at www.dot.ca.gov or 916-654-5741 for current information regarding these California statues.

RECREATION VEHICLE SERIAL NUMBER DECAL & DATA PLATES

The recreation vehicle serial number label is mounted on the inside wall next to the driver’s seat on a Class A recreation vehicle and on the inside of the driver’s door post on a Mini recreation vehicle. Refer to the chassis owner’s manual for the location of the chassis vehicle identification number on all motorized recreation vehicles.

IMPORTANT: Always give model, year, and the V.I.N. number information when ordering parts. Also, we recommend that you keep a copy of this information separate from the recreation vehicle in the event theft or vandalism requires you to supply a copy to the authorities.

Decals and data plates used throughout the recreation vehicle aid in its safe and efficient operation; others give service instructions. Read all decals, data, and instruction plates before operating your recreation vehicle.

NOTE: *When any decal, data, or instruction plate is damaged, painted over, removed, etc.; the item should be replaced immediately.*

MANUFACTURED BY: FOUR WINDS INTERNATIONAL INC. VEH. MFG. BY:	MODEL: SERIAL:	Offline: Received:
<u>KG (LB)</u>	<u>TIRES</u>	<u>RIMS</u>
	<u>COLD INFLATION PRESSURE</u>	<u>SINGLE</u>
		<u>DUAL</u>
GVWR:		
GAWR FRONT:		<input checked="" type="checkbox"/>
GAWR INTERM:		<input type="checkbox"/>
GAWR REAR:		<input checked="" type="checkbox"/>

THIS VEHICLE CONFORMS TO ALL APPLICABLE U.S. FEDERAL MOTOR VEHICLE SAFETY STANDARDS IN EFFECT IN:
 V.I.N.: TYPE: MULTI PASSENGER VEHICLE

SAFETY REGULATIONS FOR PROPANE GAS SYSTEMS & APPLIANCES

The following warnings are posted throughout the recreation vehicle to provide information on Propane safety. They have been installed not only because of the requirement to do so, but also as a constant reminder to occupants of the recreation vehicle to exercise proper caution when using or being around Propane appliances and equipment. We are listing them here so you may study them and make sure that you and your family understand and follow them.

WARNING

It is not safe to use cooking appliances for comfort heating. Cooking appliances need fresh air for safe operation. Before operation:

- 1. Open overhead vent or turn the exhaust fan ON and:**
- 2. Open windows**

This warning labels has been located in the cooking area to remind you to provide an adequate supply of fresh air for combustion. Unlike homes, the amount of oxygen supply is limited due to the size of the recreation vehicle, and proper ventilation when using the cooking appliances will avoid dangers of asphyxiation.

Over-filling the Propane gas tank can result in uncontrolled gas flow which can cause fire or explosion. A properly filled tank will contain approximately 80% of its volume as liquid Propane. An 80% automatic shut-off valve is installed on the Propane gas tank which will automatically prevent further filling when the gas volume has reached 80% of tank capacity.

CAUTION

This tank is equipped with an automatic valve designed to close at 80% liquid full. Always open 20% fixed liquid level bleeder gauge while filling. Stop filling if liquid appears before valve shuts off.

WARNING

All Propane gas is contained under pressure. Due to the dangerous potential of any compressed gas, it is mandatory that the following requirements for the use of this tank be followed: Tanks are to be installed, fueled and maintained in accordance with the state and local codes, rules, regulations or laws and in accordance with the NFPA Pamphlet 58, division IV.

Only personnel trained in the handling of Propane may fill, test or repair the Propane gas system.

WARNING

If you smell gas, extinguish any open flames, pilot lights, and all smoking materials. DO NOT touch electrical switches. Shut off the gas supply at the tank valve(s) or gas supply connection. Open doors and other ventilation openings. (do not use the range hood) Leave the area until the odor clears.

Have the system checked and leakage source corrected before using again. Propane gas regulators must always be installed with the diaphragm vent facing downward. Regulators that are not in compartments have been equipped with a protective cover. Make sure that the regulator vent faces downward and the cover is kept in place to minimize vent blockage which could result in excessive gas pressure causing fire or explosion.

WARNING

Portable fuel burning equipment including wood or charcoal burning grills and stoves should not be used inside the recreation vehicle because they may cause fire or asphyxiation.

FIRE SAFETY

Fire safety is an important part of owning a recreation vehicle. Make sure that everyone traveling in the recreation vehicle is familiar with the location of exits, including emergency exit windows should an emergency arise. The following basic rules of fire prevention can help eliminate the possibility of a fire.

- Never store flammable liquids within the recreation vehicle
- Keep cooking surfaces clean
- Never clean with a flammable liquid
- Never leave cooking food unattended
- Never smoke in bed, and always use an ashtray
- Never allow children to play with Propane gas or electrical equipment
- Never use an open flame as a flashlight
- Always repair faulty or damaged wiring and electrical components
- Never overload electrical circuits
- Locate and repair Propane gas leaks immediately
- Don't allow rubbish to accumulate
- Spray fabrics annually with a flame retardant

If a fire does start, make sure to follow these basic rules of safety:

1. Have everyone evacuate the recreation vehicle as quickly as possible
2. After everyone is clear, check the fire to see if you can attempt to put it out. If it is too large, or the fire is fuel fed, get clear of the recreation vehicle and have the fire department handle the emergency.
3. DO NOT attempt to use water to put out the fire. Water can spread some types of fire, and electrocution is possible with an electrical fire.

FIRE EXTINGUISHER

Underwriter Laboratories classify fires into three types:

Class A

Fires in wood, paper, fabric, rubber, and certain plastics

Class B

Flammable liquids such as grease, cooking oils, gasoline, or kerosene

Class C

Electrical fires started from live electrical wires, from short circuits motors or switches

The fire extinguisher, which is located by the entry door of the recreation vehicle, is a chemical type suitable for extinguishing small fires of the class B or C type. Extinguishers are designed to put out fires in the initial stage, not when it is blazing out of control. If a fire cannot be approached within 10', the extinguisher will not be effective.

To fight a fire with an extinguisher, first remove the tamper tape which covers the discharge push button. Hold it upright and stand six to ten feet from the fire with a clear path to an exit. Press the button down all the way, aimed at the base of the fire and spray with quick motions from side to side.

Avoid inhaling the dry chemicals. Although nontoxic, they could cause temporary irritation and vomiting. When the fire is out, clean up the area as soon as possible. The dry chemicals are non-corrosive, but some residue may cause surface damage if left too long.

In the case of an electrical fire, disconnect the battery and throw off the main circuit in the unit. It is important that everyone knows where to find the main circuit and how it operates. If the shoreline power cord is connected, disconnect it.

To keep the fire extinguisher in proper operating conditions:

1. **Check Pressure** monthly or more often. Check the nozzle for obstruction. Press the green pin below the nozzle. If it returns and sticks out from the extinguisher, it is operable. If the pin does not come back, discard extinguisher. Refillable models have a pressure gauge to check.
2. Check the **Tamper Tape** to make sure it is intact. DO NOT test the extinguisher. Even a partial discharge may cause leakage.
3. When checking the extinguisher for pressure, enter the date checked on the **Inspection Tag** furnished with the RV. Regular inspections will help insure the condition.
4. **Agitate Dry Chemical** every six (6) months, by inverting the bottle and lightly shaking for several seconds. This will help prevent the dry chemical from settling due to in-motion vibrations.

CARBON MONOXIDE & SMOKE DETECTOR

⚠ WARNING

This Smoke/Carbon Monoxide Alarm cannot operate without two, AA batteries. Removing the batteries for any reason, or failing to replace the batteries at the end of their service life, removes your protection. Refer to the manufacturer's owner's manual for proper replacement batteries.

This combination Smoke/Carbon Monoxide Alarm has two separate alarms. The CO alarm is not designed to detect fire or any other gas. It will only indicate the presence of CO gas at the sensor. CO may be present in other areas. The smoke Alarm will only indicate the presence of smoke that reaches the sensor. The Smoke Alarm is not designed to sense gas, heat or flames.

NOTE: *During normal operations the Power/Smoke LED flashes Green once per minute, and the CO LED is off.*

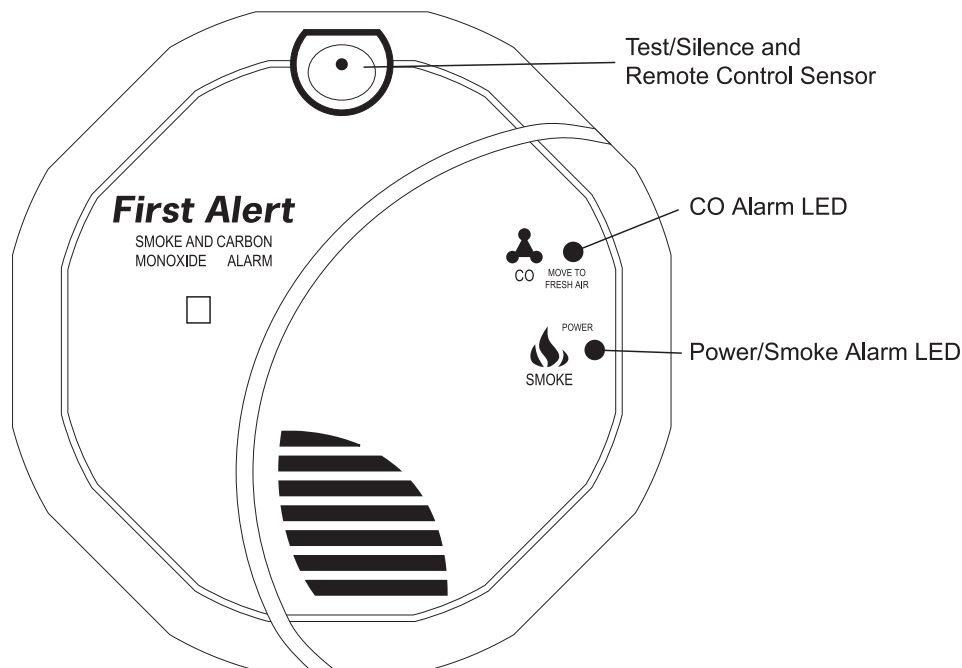

Programming the Alarm

Refer to the Combination Carbon Monoxide & Smoke Alarm User's Manual within your Owner's Packet for detailed setup information.

Testing Procedure

WARNING

DO NOT stand close to the alarm when the horn is sounding. Exposure at close range may be harmful to your hearing. When testing, step away when the horn starts sounding.

Never use an open flame of any kind to test this unit. The built-in test switch accurately tests the unit's operation as required by Underwriters Laboratories, Inc. (UL).

TEST: *It is important to test this unit before each trip and once every week to ensure it is working properly. Using the test button is the recommended way to test this Smoke/CO Alarm.*

You can test this Smoke/CO Alarm two ways:

1. Manually: Press and hold the Test/Silence button on the alarm cover until alarm voice says "Testing" (typically 3-5 seconds).
2. Using Your Remote Control: Standing no further than 20 feet (6 meters) away from the Smoke/CO Alarm, aim the IR remote at the alarm and press the CHANNEL or VOLUME button until alarm voice says "Testing".

If the alarm does not respond to your remote control, there may be an obstruction between you and the alarm, you may be standing too far away, or your remote control may not be compatible.

During testing, you will see and hear the following sequence.

- The alarm voice will say "Testing". The horn will sound 3 beeps, pause, 3 beeps. The alarm voice will say "Warning, evacuate smoke in location. Evacuate." The Power/Smoke LED flashes Red and the CO LED will be off.
- Next the Horn will sound 4 beeps, pause, 4 beeps. The alarm voice will say "Warning, evacuate carbon monoxide in location. Evacuate". The Power/Smoke LED will be off and the CO LED flashes red.

NOTE: *If the unit does not alarm, make sure the batteries are correctly installed, and test again. If the unit still does not alarm, replace it immediately.*

Carbon Monoxide Safety Precautions

WARNING

DO NOT alter or modify any component of the exhaust system at any time. Inspect the exhaust system at regular intervals for damage. If you suspect or locate damage to the system, have it repaired immediately by a qualified service facility.

Never sleep while the engine is running. Be aware of carbon monoxide poisoning and its symptoms: Dizziness, Severe Headache, Vomiting, Weakness, Sleepiness, Muscular Twitching, and Throbbing in Temples. If anyone in the recreation vehicle experiences any of these symptoms, shut off the engine, and immediately go outside into fresh air. Get medical attention as soon as possible.

Carbon Monoxide cannot be seen or smelled and can kill you. If alarm sounds: Turn off appliances, as well as other sources of combustion at once (furnace, water heater, stove, recreation vehicle, automobile, etc.) and call the fire department. Get fresh air into the premises or vehicle. Have the problem corrected before starting any appliances or the vehicle.

Never run the engine and/or the generator unless you are sure that exhaust gases will be safely dispersed into the atmosphere. Always be sure that exhaust tail pipes remain unblocked and windows near the exhaust are closed.

PROPANE GAS DETECTOR

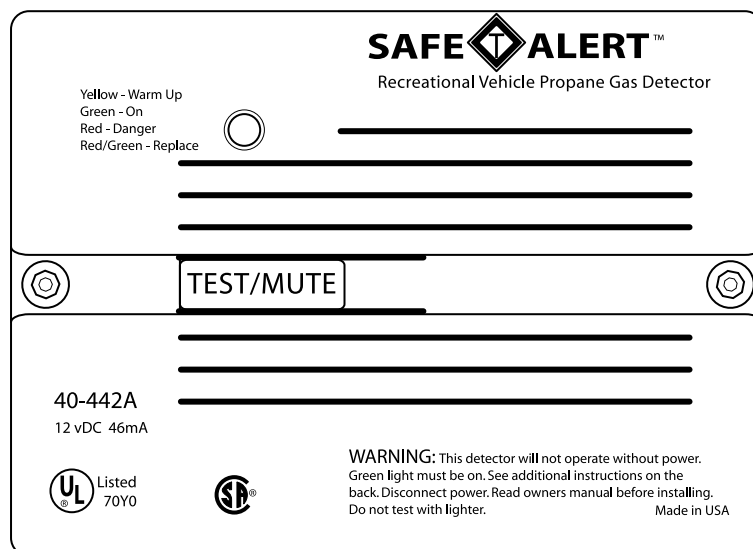

The Propane Gas Detector is powered at all times when the coach battery disconnect switch is in the ON position. When power is supplied to the detector the green indicator light will illuminate. After 60 seconds, the detector will begin monitoring the air in the recreation vehicle for combustible vapors. The Propane you use to cook, refrigerate, and heat is combustible. Should a leak occur, the detector will produce a pulsating alert sound when the gas reaches the detector. This alert will continue to sound until the gas has dissipated or until the reset button is pressed. When the alert sounds, open all doors and major windows to air out the recreation vehicle and turn the gas off at the tank. Do not reenter the recreation vehicle until the alert stops sounding. If the alert sounds a second time after the gas is turned back on, leave the gas off and have a qualified Propane Dealer or RV Service Center make the necessary repairs. The reset button only stops the alert from sounding for 60 seconds. This device is intended for detection of Propane gas ONLY.

Maintenance

NOTICE

Never use water, cleaners or solvents to clean the detector.

The following maintenance steps should be taken to ensure proper function of the detector.

- Test the detector at least once per week.
- Clean the detector at least once a month; gently vacuum the outside of the detector using the vacuums soft brush attachment.
- If detector becomes contaminated by excessive dirt, dust and/or grime, and cannot be cleaned to avoid unwanted alarms, replace the unit immediately.

REFERENCE: For proper battery maintenance and replacement procedures, refer to the manufacturer's owner's manual.

How to Test

WARNING

Never use an open flame of any kind to test this unit. The built-in test switch accurately tests the unit's operation as required by Underwriters Laboratories, Inc. (UL).

Simply press the TEST switch any time during the warm-up cycle or while in normal operation. The LED should flash red and the alarm should sound. Release the switch. This is the only way you should test your detector. The test feature checks the full operation of the detector. If this detector does not test properly return it immediately for repair or replacement.

TEST: *This test procedure should be repeated every week or every time the recreation vehicle is taken on a trip, whichever occurs first.*

REFERENCE: *Refer to the manufacturer's Owner's Manual or all the detector manufacturer, if you have any questions about the Propane Gas Detector.*

Checking the Propane System for Leaks

WARNING

Never check for leaks with an open flame. The scent of Propane (a garlic-like odor) is actually ethyl mercaptan, an additive that allows you to detect the presence of a leak, since Propane is naturally odorless. Do not rely upon being able to detect the smell of the gas, as the odor may fade.

Road vibration can loosen Propane fittings. It is important to check the Propane system for leaks at least every 5,000 miles, and whenever the tank is filled. It is also a good idea to have the entire Propane system checked annually by a qualified Propane service representative.

Use the following steps when checking the system for leaks:

1. Open all the windows and vents.
2. Open the gas tank service valve.
3. Use non-ammoniate, non-chlorinated soap solution, or an approved leak detection solution on all line connections (ammoniate soap solutions can cause cracking on copper or brass lines and fittings).
4. If a leak is detected, tighten the connection with two open end wrenches until bubbling stops. DO NOT over tighten, or use excessive force. If the leak continues, contact the recreation vehicle dealer, or a qualified Propane service representative to have an 11" Water Column Test performed.

About the Propane Gas Detector

Liquefied Petroleum Gas (Propane) is heavier than air and will settle to the lowest point which is generally the floor of the recreation vehicle. The detector is also sensitive to other fumes such as hair spray of which most contain butane as the propellant. Butane, like Propane, is heavier than air and will settle to the floor level where it will be detected. When this occurs, press the reset button to stop the alert sound for 60 seconds.

Other combustibles which will be detected include alcohol, liquor, deodorants, colognes, perfumes, wine, adhesives, lacquer, kerosene, gasoline, glues, most of all cleaning agents and the propellant's of aerosol cans. Most are lighter than air in their vapor state and will only be detected when the coach is closed up. Glues and adhesives may exhaust hydrocarbon vapors for months after they are applied. They are easily activated by high temperatures.

The Propane Gas Detector is powered by the recreation vehicle coach batteries and/or the inverter. The detector will operate properly until the battery is drained down to 10 volts (a low battery condition is 10.4 volts). If the power source (battery and/or inverter) is disconnected, or if the power is otherwise interrupted, the detector will not operate.

The Propane Gas Detector has a self check circuit which runs at all times when the detector is powered. In the event that the circuitry fails, a failure alarm will sound. It is a continuous series of short beep tones between long intervals and is distinctively different from the alert sound.

Most Common Causes of Apparent Malfunction

- **New Coach Odor:** The glues and other materials used in manufacturing the coach produce vapors which may be detected when the coach is closed up on a warm day. Air out the recreation vehicle thoroughly.
- **Keeps Beeping:** The gas detector beeps about once every minute, even when it is turned off. The problem is a weak battery in the smoke detector which causes the smoke detector to produce short beeps which sound similar to the alert sound of the Propane Gas Detector. This is a high pitch tone and bounces off the walls, making its location very hard to pinpoint. If the sound is not coming from the Propane Gas Detector identify the source and refer to the sources section in this manual for means of repair.
- **Hair Spray Triggers the Detector:** Most aerosol hair sprays use butane gas as the propellant. Butane, like Propane, is heavier than air and will settle to the floor level where it will be detected. The detector is doing its job as butane is combustible.
- **Other Gases:** Other gases which can cause the detector to respond with an alert include the vapors from any fuel, liquor, alcohol, deodorants, colognes, perfumes, wine, adhesives, lacquer, and most cleaning agents.
- **Slow Beep Rate:** This could be the failure alarm and will occur in the event that the circuitry fails. It is a continuous series of short beep tones between long intervals and is distinctively different from the alert sound.
- **After reviewing the above, if the problem still exists, contact MTI Industries for assistance.** Contact information may be found in the *"Care & Maintenance"* section of this manual under the heading of *"Vendor Contact Information"*.

NOTE: *The Propane Gas Detector enters a cleaning and initializing mode every time it is powered. If turned OFF for less than 15 minutes, the Propane Gas Detector may produce several short “chirps” within the first 80 seconds of operation. This is a normal function of the LP Gas Detector.*

See your Four Winds International Dealer or a qualified Propane Service Center should service be required. If they are not familiar with this product, have them call the detector manufacturer for assistance. If service is not available in your area, call MTI Industries.

Propane Safety Precautions

⚠ WARNING

DO NOT store Propane containers inside the recreation vehicle. Propane containers are equipped with safety devices which relieve excessive pressure by discharging gas to the atmosphere.

If you smell gas:

1. Extinguish any open flames, pilot lights and all smoking materials.
2. DO NOT touch any electrical switches.
3. Shut off the gas supply at the tank valve(s) or gas supply connection.
4. Open all doors and other ventilating openings. (DO NOT USE THE RANGE HOOD).
5. Leave the area until the odor clears.
6. Have the system checked by a trained professional before using again.

Be careful when doing any work or maintenance in the recreation vehicle, that you do not puncture a gas line with a nail, screw, or drill bit.

Warning labels and decal's are used throughout the recreation vehicle in locations where the potential for a dangerous situation is present. They have been installed not only because of the requirement to do so, but also as a constant reminder to occupants of the recreation vehicle to exercise proper caution when using or being around Propane appliances and equipment. Make sure that you and your family understand and follow all of them. Never remove these warning labels and decal's. If one should be lost, it should be replaced as soon as possible.

CHEMICAL SENSITIVITY

After you first purchase your new recreation vehicle and sometimes after it has been closed up for an extended period of time you may notice a strong odor and chemical sensitivity. This is not a defect in your recreation vehicle. Like your home, there are many different products used in the construction of recreation vehicles such as carpet, linoleum, plywood, insulation, upholstery, etc. Formaldehyde is also the by-product of combustion and numerous household products, such as, some paints, coatings and cosmetics. However, recreation vehicles are much smaller than your home and therefore the exchange of air inside a recreation vehicle is significantly less than a home. These products, when new or when exposed to elevated temperatures and/or humidity, may "off-gas" different chemicals, including formaldehyde. This off-gassing, in combination with the minimal air exchange, may cause you to experience irritation of the eyes, nose, and throat and sometimes headache, nausea, and a variety of asthma-like symptoms. Elderly persons and young children, as well as anyone with a history of asthma, allergies, or lung problems, may be more susceptible to the effects of off-gassing.

Formaldehyde

Most of the attention regarding chemical off-gassing surrounds formaldehyde. Formaldehyde is a naturally occurring substance. It is also a key industrial chemical used in the manufacture of the numerous consumer products which we referred to above and used in the construction of recreation vehicles. Trace levels of formaldehyde are also released from smoking, cooking, use of soaps and detergents such as carpet shampoos, cosmetics, and many other household products. Some people are very sensitive to formaldehyde while others may not have any reaction to the same levels of formaldehyde. Amounts released decrease over time.

Ventilation

To reduce or lessen exposure to chemicals from off-gassing it is of utmost importance that you ventilate your recreation vehicle. Ventilation should occur frequently after purchase and at times when the temperatures and humidity are elevated. Remember off-gassing is accelerated by heat and humidity. Open windows, exhaust vents, and doors. Operate ceiling and/or other fans, roof air conditioners, and furnaces and use a fan to force stale air out and bring fresh air in. Decreasing the flow of air by sealing the recreation vehicle increases the formaldehyde level in the indoor air. Please also follow the recommendations contained in "Care & Maintenance" section regarding tips to avoid condensation problems.

NOTE: *We recommend that you do not smoke inside your recreation vehicle. In addition to causing damage to your recreation vehicle, tobacco smoke releases formaldehyde and other toxic chemicals.*

NOTE: *If you have any questions regarding the health effects of formaldehyde, please consult your doctor or local health department.*

NOTE: *Chemical off-gassing is not a defect in your recreation vehicle and is not covered by the Limited Warranty. Please follow the recommendation in this section to address this concern.*

SEAT BELTS

WARNING

Do not occupy beds or any other seats that are not equipped with safety seat belts while the recreation vehicle is in motion. Do not use a seat belt on more than one person.

Pilot & co-pilot seats must be locked in a forward facing position with seat belts fastened while the recreation vehicle is in motion. Avoid seat rotation while in transit.

The sleeping accommodations in this vehicle are designed for occupancy only while the vehicle is parked. All occupants in this vehicle must be seated at a designated seating position and must wear seat belts at all times while this vehicle is in motion.

Safety belts and seats can become hot in a vehicle that has been closed up in sunny weather; they could burn a small child. Check seat covers and buckles before you place a child anywhere near them.

Seat Belt Operation

All occupants must be furnished with and use seat belts while the recreation vehicle is moving. However, it is not intended for all seats to be simultaneously occupied while the vehicle is in motion without regard to the total loaded weight of the vehicle.

- Insert the belt tongue into the proper buckle (the buckle closest to the direction the tongue is coming from) until you hear a snap and feel it latch. Make sure the tongue is securely fastened in the buckle.
- Adjust the belt to the proper position; snug and as low as possible around the hips, not around the waist.
- To unfasten, push the release button and remove the tongue from the buckle.

Maintenance

WARNING

Failure to inspect and if necessary replace the safety belt under the above conditions could result in severe personal injuries in the event of a collision.

Inspect the safety belts periodically to make sure they work properly and are not damaged. Inspect the safety belts to make sure there are no nicks, tear or cuts. Replace if necessary. A qualified service technician should inspect all safety belt assemblies after a collision. Four Winds International recommends that all safety belt assemblies used in vehicles involved in a collision be replaced.

Child Restraints

WARNING

Rear-facing child seats or infant carriers should never be placed in the front seats.

Never let a passenger hold a child on his or her lap while the vehicle is moving.

You are required by law to use safety restraints for children in the U.S. and Canada. If small children (generally children who are four years old or younger and who weigh 18 kg [40 lbs] or less) ride in your vehicle, you must put them in safety seats made especially for children.

NOTE: *Check your local and state or provincial laws for specific requirements regarding the safety of children in your vehicle.*

NOTE: *Always follow the instructions and warnings that come with any infant or child restraint you might use.*

If the child is the proper size, restrain the child in a safety seat. Children who are too large for child safety seats (as specified by your child safety seat manufacturer) should always wear safety belts.

If the shoulder belt portion of a combination lap and shoulder belt can be positioned so it does not cross or rest in front of the child's face or neck, the child should wear the lap and shoulder belt.

Booster Seats

WARNING

Never use pillows, books, or other objects to boost a child.

Children outgrow a typical convertible or toddler seat when they weigh 40 pounds and are around 4 years of age. Although the lap/shoulder belt will provide some protection, these children are still too small for lap/shoulder belts to fit properly, which could increase the risk of serious injury.

To improve the fit of both the lap and shoulder belt on children who have outgrown child safety seats, Four Winds International recommends use of a belt-positioning booster.

Booster seats position a child so that safety belts fit better. They lift the child up so that the lap belt rests low across the hips and the knees bend comfortably. Booster seats also make the shoulder belt fit better and more comfortably for growing children. Follow all instructions provided by the manufacturer of the booster seat.

EGRESS WINDOW

An egress window is designated for use as an exit in the case of an emergency. Inside the recreation vehicle the egress window is easily identified by the red locking handles. There are two common styles of latches, determine the style of locking handle you have and refer to the following illustrations for operation. It is also marked as an "EXIT". The glass slider in the egress window operates the same as all other windows;

NOTE: *On select floor plans the egress window in the bedroom is located behind two mirrored cabinet doors. Open the cabinet doors to gain access to the egress window.*

TO RELEASE THE EGRESS LATCHES,
PULL THE HANDLES TOWARDS ONE ANOTHER

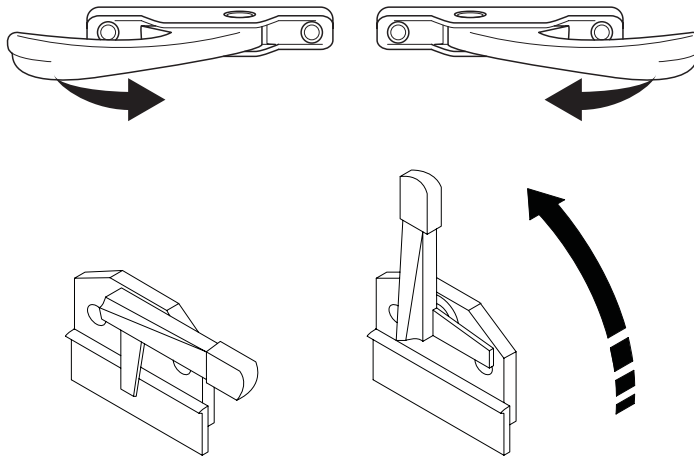

TO RELEASE EGRESS LATCHES,
PULL THE HANDLES UP

TEST: *The egress window should be opened twice a year to ensure proper operation. Over time, the rubber seal will tend to stick to the egress window. Occasional operation will help prevent the rubber seal from sticking.*

CHASSIS OPERATIONS & PROCEDURES

All issues regarding the Chassis Warranty, Parts & Service should be directed to the chassis manufacturer.

The chassis is an integral part of the recreation vehicle and with proper care and maintenance can provide many miles of reliable travel. The following section is for reference only, for detailed information regarding, product information and proper maintenance of the chassis, refer to the chassis manufactures owner's manual.

You as the owner are the key to keeping your recreation vehicle in good operating condition, as well as being responsible for taking the proper precautions when attempting any repair or maintenance activities. If you are not sure what action to take, or uncomfortable with performing a maintenance or repair function, contact your dealer, or a designated chassis manufacturer servicing dealer. Check information supplied by chassis manufacturer for a service dealer near you.

Special procedures or schedules for "breaking-in" your new recreation vehicle are minimal. Make sure to follow the recommendations as outlined in the chassis owner's manual to ensure proper future performance and economy.

REFERENCE: *Make sure to read all chassis information supplied by the chassis manufacturer, paying particular attention to precautionary notes and warnings, as well as all maintenance procedures and schedules.*

REFERENCE: *The recreation vehicle may have an Event Data Recorder, refer to the chassis owner's manual for further details.*

BRAKES

Operation and maintenance of the brake system is covered in the chassis owner's manual. Always be sure to keep your brakes in proper working condition, following the service schedule in the chassis owner's manual, and the recommendations of your chassis service representative.

TIRES

Studies of tire safety show that maintaining proper tire pressure, observing tire and recreation vehicle load limits (not carrying more weight in your recreation vehicle than the tires or vehicle can safely handle), avoiding road hazards, and inspecting tires for cuts, slashes, and other irregularities are the most important things you can do to avoid tire failure, such as tread separation or blowout and flat tires. These actions, along with other care and maintenance activities, can also:

- Improve vehicle handling
- Help protect you and others from avoidable breakdowns and accidents
- Improve fuel economy
- Increase the life of your tires

Use this information to make tire safety a regular part of your motohome maintenance routine. Recognize that the time you spend is minimal compared with the inconvenience and safety consequences of a flat tire or other tire failure.

Properly maintained tires improve the steering, stopping, traction, and load-carrying capability of the recreation vehicle. Underinflated tires and overloaded recreation vehicles are a major cause of tire failure. Therefore, as mentioned above, to avoid flat tires and other types of tire failure, you should maintain proper tire pressure, observe tire and vehicle load limits, avoid road hazards, and regularly inspect your tires.

Finding the Recommended Tire Pressure & Load Limits

Tire information placards and recreation vehicle certification labels contain information on tires and load limits. These labels indicate the recreation vehicles manufacturer's information including:

- Recommended tire size
- Recommended tire inflation pressure
- Vehicle capacity weight (VCW - the maximum occupant and cargo weight a vehicle is designed to carry)
- Front and rear gross axle weight ratings (GAWR - the maximum weight the axle systems are designed to carry)

Both placards and certification labels are permanently affixed to the recreation vehicles interior sidewall. Locate the placards and labels near the drivers seat, or within the bedroom wardrobe closet.

Understanding Tire Pressure & Load Limits

Tire inflation pressure is the level of air in the tire that provides it with load-carrying capacity and affects the overall performance of the recreation vehicle. The tire inflation pressure is a number that indicates the amount of air pressure- measured in pounds per square inch (psi)- a tire requires to be properly inflated. (You will also find this number on the recreation vehicle information placard expressed in kilopascals (kPA), which is the metric measure used internationally.)

Vehicle manufacturers determine this number based on the vehicle's design load limit, that is, the greatest amount of weight a vehicle can safely carry and the vehicle's tire size. The proper tire pressure for the recreation vehicle is referred to as the "recommended cold inflation pressure". (As you read below, it is difficult to obtain the recommended tire pressure if the tires are not cold.)

Because tires are designed to be used on more than one type of vehicle, tire manufacturers list the "maximum permissible inflation pressure" on the tire sidewall. This number is the greatest amount of air pressure that should ever be put in the tire under normal driving conditions.

Checking Tire Pressure

It is important to check your recreation vehicles tire pressure before each trip for the following reasons:

- Most tires may naturally lose air over time
- Tires can lose air suddenly if you drive over a pothole or other object or if you strike the curb when parking
- With radial tires, it is usually not possible to determine under inflation by visual inspection

NOTE: *For convenience, purchase a tire pressure gauge to keep in the recreation vehicle. Gauges can be purchased at tire dealerships, auto supply stores, and other retail outlets.*

The recommended tire inflation pressure that vehicle manufacturers provide reflects the proper psi when a tire is cold. The term cold does not relate to the outside temperature. Rather, a cold tire is one that has not been driven on for at least three hours. When you drive, your tires get warmer, causing the air pressure within them to increase. Therefore, to get an accurate tire pressure reading, you must measure tire pressure when the tires are cold or compensate for the extra pressure in warm tires.

Tire Size

To maintain tire safety, purchase new tires that are the same size and rating as the recreation vehicles original tires or another size recommended by the manufacturer. Look at the tire information placard, the chassis owner's manual, or the sidewall of the tire you are replacing to find this information. If you have any doubt about the correct size to choose, consult with the tire dealer and chassis manufacturer.

Tire Tread

The tire tread provides the gripping action and traction that prevent the recreation vehicle from slipping or sliding, especially when the road is wet or icy.

A tread depth gauge is recommended to check your tread depth. But also a simple way to check the tread depth of your tires is by using a penny. Take a penny and put Abe's head into each of the grooves of the tire tread. If part of his head is covered by the tread, you're driving with the legal amount of tread. If you can see all of Abe's head, your tread is down to 2/32" and it's time to replace the tire.

Built-in tread wear indicators, or "wear bars," which look like narrow strips of smooth rubber across the tread, will appear on the tire when that point of wear is reached. When you see these wear bars, the tire is worn out and it is time to replace it.

NOTE: *On vehicles with GVWR in excess of 10,000 lbs., federal regulations require that tires on the front axle must be removed when worn down to 4/32" depth. Please use a tread depth gauge to check your tires.*

If you have any doubt about the tread depth on your tires, consult a tire service professional.

Tire Balance & Wheel Alignment

To avoid vibration or shaking of the recreation vehicle when a tire rotates, the tire must be properly balanced. This balance is achieved by positioning weights on the wheel to counterbalance heavy spots on the wheel-and-tire assembly. A wheel alignment adjusts the angles of the wheels so that they are positioned correctly relative to the vehicle's frame. This adjustment maximizes the life of your tires. These adjustments require special equipment and should be performed by a qualified technician.

NOTE: *The front end alignment of the recreation vehicle has been set by the body builder. For the recreation vehicle in its unloaded or empty condition. However, since alignment is affected by not only how much weight you add to the recreation vehicle in the way of cargo and how you disperse the cargo, we advise you to have the recreation vehicle alignment checked in the loaded condition (the way you would travel down the road). Not having the alignment set in the loaded condition could result in abnormal tire wear, which is not covered under the limited warranty.*

Tire Rotation

The purpose of regularly rotating tire is to prolong their useful tire life by achieving more uniform wear for all tires on the recreation vehicle. Before rotating tires, check the chassis owner's manual for rotation recommendations for specific vehicles. If no rotation period is specified, speak with a qualified service technician or the tire manufacturer.

NOTE: Some kinds of tires cannot be rotated in the manners described below. Such tires include uni-directional tires and tires with asymmetric tread designs. Also, some vehicles may have different-sized tires mounted on the front and rear axles, and these different-sized tires have rotation restrictions. Check the chassis manual, or with a tire dealer, for the proper rotation recommendations for these special cases.

When tires are rotated, the inflation pressures must be adjusted for the tire's new positions in accordance with the actual loads on that wheel position. Underinflated or overinflated tires may result in poor handling, uneven treadwear and increased fuel consumption.

NOTE: Lugnuts should be properly torqued anytime a tire/wheel/rim assembly is reinstalled on the recreation vehicle. Refer to the chassis owner's manual for detailed information regarding wheel nut torques.

MOTORHOME TIRE ROTATION PATTERNS

(Only Where Tires are Same Type & Size)

REAR TIRE IRREGULAR WEAR

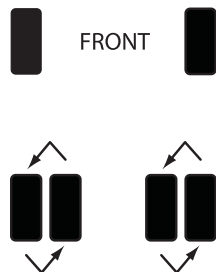

FRONT TIRE IRREGULAR WEAR

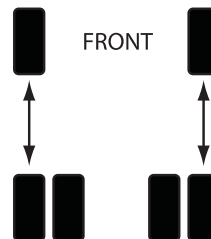

SIX-TIRE ROTATION

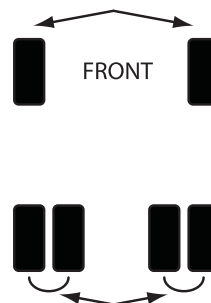
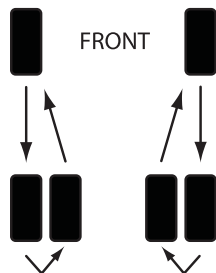

Tire Repair/Replacement

⚠ CAUTION

When replacing a tire, make sure that service personnel replace it with a tire of the same size and specifications.

The proper repair of a punctured tire requires a plug for the hole and a patch for the area inside the tire that surrounds the puncture hole. Punctures through the tread can be repaired if they are not too large, but punctures to the sidewall should not be repaired. Tires must be removed from the rim to be properly inspected before being plugged and patched.

If you notice damage to a tire such as a bulge, uneven wear, or damage by a foreign object or the road, have it inspected and repaired or replaced as needed. Remember that tires should be taken to an authorized tire repair facility.

NOTE: *If you experience a flat tire, it is recommended that you have qualified personnel with the proper equipment handle the problem. Due to the size and weight of a recreation vehicle wheel and tire assembly, as well as the amount of torque needed to tighten wheel nuts securely, it is best to call in a professional. It is for this reason that a jack has not been included in this recreation vehicle.*

Wheel Nut Torque

⚠ WARNING

Failure to torque wheel nuts as specified could allow wheels to come off while the recreation vehicle is in motion, causing loss of control and possible collision.

Follow the schedule for regular wheel nut checks as outlined in the chassis manufacturer's owner's manual. If you suspect that the wheel nuts have loosened at any time, have the wheel nuts checked, and if necessary torque the nuts to the proper limits immediately.

If you suspect or notice wheel stud bolts are cracked or broken, they must be replaced, along with adjacent bolts that have probably also been weakened due to additional stress placed on them. You, as the owner of the recreation vehicle, need to make frequent inspections of the wheels and tires, looking for signs of wear or damage. Avoid abusive driving such as impacting curbs and pot holes at high speeds.

NOTE: *The proper way of tightening wheel nuts is with a torque wrench, not with an impact wrench or by hand. Because of the importance of having the proper torque on wheel nuts, you should have wheels mounted by authorized personnel with the proper tools.*

Tire Fundamentals

Federal law requires tire manufacturers to place standardized information on the sidewall of all tires. This information identifies and describes the fundamental characteristics of the tire and also provides a tire identification number for safety standard certification and in case of a recall.

MOTORHOME TIRES

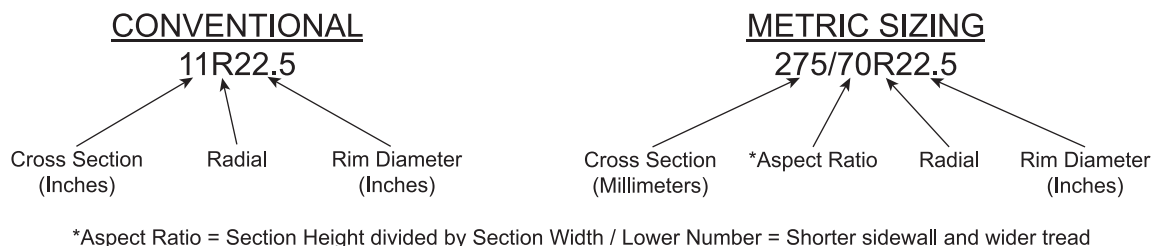

U.S. DOT Tire Identification Number

This begins with the letters “DOT” and indicates that the tire meets all federal standards. For example, the number may read MC3TPXAW1204. The first two letters (MC) are the Manufacturer Plant Code, the next two (3T) are the Government Size and Ply Code. The following four letters (PXAW) are the Manufacturer Construction Code. The last four numbers, referred to as the Tire Build Date (1204) represent the week and year the tire was built. The Tire Build Date would be read as the 12th week of 2004.

RECREATION VEHICLE LOAD LIMITS

NOTICE

CAUTION: Do not overload the recreation vehicle.

Determining the load limits of a recreation vehicle includes more than understanding the load limits of the tires alone. On the recreation vehicle, there is a Federal Certification Label that is affixed to the interior sidewall next to the driver’s seat. The certification label will indicate the recreation vehicles gross vehicle weight rating (GVWR). This is the most weight the fully loaded recreation vehicle can weigh. It will also provide the gross axle weight rating (GAWR). This is the most a particular axle can weigh. If there are multiple axles, the GAWR of each axle will be provided.

In the main bedroom closet there is a vehicle placard. This placard provides tire and loading information. In addition, this placard will show the recreation vehicles seating capacity for people and a statement regarding maximum cargo capacity.

Weight Terms

The following is an explanation of commonly used weight abbreviations.

- Gross Vehicle Weight Rating (**GVWR**) is the maximum permissible weight of this recreation vehicle.
- Unloaded Vehicle Weight (**UVW**) is the weight of this recreation vehicle as manufactured at the factory with full fuel, engine oil, and coolants.
- Cargo Carrying Capacity (**CCC**) is equal to the GVWR minus each of the following: UVW, full fresh (potable) water weight (including water heater), full propane weight and SCWR.
- Gross Combined Weight Rating (**GCWR**) means the maximum allowable loaded weight of this recreation vehicle with its towed trailer or towed vehicle.
- Sleeping Capacity Weight Rating (**SCWR**) is the manufacturer's designated number of sleeping positions multiplied by 154 pounds (70 kilograms).
- Gross Axle Weight Rating (**GAWR**) is the value specified as the load carrying capacity of a single axle system, as measured at the tire-ground interfaces.

Weight Label (Example)



701 CR 15
PO Box 1486
Elkhart, IN 46516-9731

MOTORHOME WEIGHT SPECIFICATIONS
SPÉCIFICATIONS DE POIDS CONCERNANT LES MOTOR-HOMES

PRODUCT: <small>Produit:</small>	SERIAL #: <small>N° de série:</small>	
MODEL: <small>Modèle:</small>	YEAR: <small>Année:</small>	CHASSIS VIN #: <small>N° d'identification du véhicule sur le châssis:</small>

LBS - livres **KG / kilos**

Gross Axle Weight Rating - GAWR

Maximum permissible load carried by an axle - (sum of rating may exceed GVWR).
Estimation du poids brut de l'essieu
 Poids maximum permis pouvant être supporté par un essieu (le total de l'estimation peut excéder l'estimation du poids brut du véhicule).

Front:
Avant:
Rear:
Arrière:

Gross Vehicle Weight Rating - GVWR

Maximum permissible weight of this fully loaded motorhome.
Estimation du poids brut du véhicule
 Poids maximum permis de cet motor-home chargé à fond.

Gross Combined Weight Rating - GCWR

Maximum allowable load weight of this motorhome and any towed trailer or towed vehicle.
Estimation du poids brut combiné
 Poids maximum de charge alloué pour cette motorhome et toute remorque ou voiture remorquée.

Unloaded Vehicle Weight - UVW

Weight of this motorhome as manufactured at the factory with full fuel, engine oil and coolants.
Poids du véhicule sans charge
 Poids de cet motor-home tel que fabriqué à l'usine avec un plein d'essence, d'huile de moteur et des fluides de refroidissements.

Sleeping Capacity Weight Rating - SCWR

Motorhome manufacturer's designated number of sleeping positions multiplied by 154 pounds (70 kilograms).
Estimation du poids de capacité de couchage
 Le nombre de position de couchage tel qu'indiqué par le fabricant du motor-home multiplié par 154 livres (70 kilogrammes).

Cargo Carrying Capacity - CCC

Equal to GVWR minus each of the following: UVW, Full fresh (potable) water (including water heater), full LP gas weight and SCWR.
 (Note: dealer installed equipment and towed vehicle tongue weight will reduce CCC)
Capacité de transportation de cargo
 égal à l'estimation du poids brut du véhicule moins chacun des suivants: le poids du véhicule sans charge, le poids du plein d'eau potable (incluant chauffe-eau), le poids du plein d'essence et l'estimation du poids de capacité de couchage.
 (Note: les équipements installés par le concessionnaire et le poids du véhicule remorqué sur la boule de remorque vont réduire la capacité de transportation de cargo.)

Fresh water w/ water heater @ 8.33 lbs./gal.	Gals.
Eau potable avec chauffe-eau @ 1 kg/litre	litres.
LPG capacity @ 4.2 lbs./gal	Gals.
Capacité d'essence @ 0.54 kg/litre	litres.

WARNING: This information is intended as a guide only. Weights of individual vehicles may vary. Consult Owners Manual(s) for specific weighing instructions and towing guidelines including auxiliary brake requirements for any towed trailer or towed vehicle.
Caution: Consulter le manuel du propriétaire pour les instructions spécifiques de pesage et les directions de remorquage incluant les exigences de freins auxiliaires pour toute remorque ou voiture remorquée.



Cargo Capacities

Cargo can be added to the recreation vehicle, up to the maximum weight specified on the placard. For motorized vehicles, the combined weight of passengers and cargo is provided as a single number. If fewer people are traveling, more cargo can be added. If more people are involved, the weight of cargo must be reduced. In any case, remember: the total weight of a fully loaded vehicle, including passengers, can not exceed the stated GVWR.

Water and propane also need to be considered. The weight of fully filled propane containers is considered part of the weight of the recreation vehicle before it is loaded with people or cargo and is not considered part of the disposable cargo load. Water however, is a cargo weight and is treated as such. If there is a fresh water storage tank of 100 gallons, this tank when filled would weigh about 800 pounds. If more cargo or people are being transported, water can be off-loaded to keep the total amount of cargo added to the recreation vehicle within the limits of the GVWR so as not to overload the recreation vehicle. Understanding this flexibility will allow you, the owner, to make choices that fit your travel and camping needs.

NOTE: *Four Winds International does not recommend traveling with the fresh water tank at full capacity.*

When loading your cargo, be sure it is distributed evenly to prevent overloading front to back and side to side. Heavy items should be placed low and as close to the axle positions as reasonable. Too many items on one side may overload a tire. The best way to know the actual weight of the vehicle is to weigh it at a public scale. Talk to your RV dealer to discuss the weighing methods needed to capture the various weights related to the RV. This would include weights for the following: axles, wheels, hitch or pin (in the case of a trailer) and total weight.

How Overloading Affects the recreation vehicle & Tires

The results of overloading can have serious consequences for passenger safety. Improper weight distribution or too much weight on your recreation vehicles suspension system can cause spring, shock absorber, or brake failure, handling or steering problems, irregular tire wear, tire failure or other damage.

An overloaded recreation vehicle is hard to drive and hard to stop. In cases of serious overloading, brakes can fail completely, particularly on steep hills. The load a tire will carry safely is a combination of the size of tire, its load range, and corresponding inflation pressure.

Excessive loads and/or under inflation cause tire overloading and, as a result, abnormal tire flexing occurs. This situation can generate an excessive amount of heat within the tire. Excessive heat may lead to tire failure.

Tire Safety Tips

It is the air pressure that enables a tire to support the load, so proper inflation is critical. Since recreation vehicles can be configured and loaded in many ways, air pressures must be determined from actual loads (determined by weighing) and taken from the load and inflation tables provided by the tire manufacturer. These air pressures may differ from those found on the certification label. However, they should never exceed the tire limitation for load or air pressure. If you discover that your tires cannot support the actual weights, the load will need to be lightened.

Preventing Tire Damage

- Slow down if you have to go over a pothole or other object in the road.
- Do not run over curbs or other foreign objects in the roadway, and try not to strike the curb when parking.

Tire Safety Checklist

- Check tire pressure regularly (at least once a month).
- Inspect tires for uneven wear patterns on the tread, crack, foreign objects, or other signs of wear or trauma.
- Remove bits of glass and foreign objects wedged in the tread.
- Make sure your tire valves have valve caps.
- Check tire pressure before going on a long trip.
- Do not overload your recreation vehicle. Check the Tire Information and Loading Placard or Chassis Manual for the maximum recommended load for the recreation vehicle.

Determining Correct Load Limit

1. Locate the statement "The combined weight of occupants and cargo should never exceed XXX lbs on the recreation vehicle placard".
2. Determine the combined weight of the driver and passengers that will be riding in the recreation vehicle.
3. Subtract the combined weight of the driver and passengers from the XXX kilograms or XXX pounds.
4. The resulting figure equals the available amount of cargo and luggage capacity. For example, if the "XXX" amount equals 1400 lbs. and there will be five 150 lb. passengers in the recreation vehicle, the amount of available cargo and luggage capacity is 650 lbs. (1400-750 (5 x 150) = 650 lbs.)
5. Determine the combined weight of luggage and cargo being loaded on the vehicle. That weight may not safely exceed the available cargo and luggage capacity calculated in Step #4.
6. If the recreation vehicle will be towing a trailer, load from the trailer will be transferred to the recreation vehicle. Consult this manual to determine how this reduces the available cargo and luggage capacity of the recreation vehicle.

SPARE TIRE

A spare tire may not be available for your model of recreational vehicle.

Spare Tire Hoist

NOTICE

This hoist is designed for manual use with the driving tool only. A pneumatic wrench should never be used to drive a hoist, damage will result.

To Lower the Spare Tire:

1. Remove the travel nut on the spare tire.
2. Locate access hole in rear bumper behind license plate of the recreation vehicle, or access the driving feature for the hoist.
3. Insert driving tool into access hole until end of driver comes into contact with hoist drive feature. This may be a hex on the end of a drive extension tube, or an actuator feature on the end of hoist drive shaft.
4. Rotate drive tool and hoist drive shaft in counter-clockwise direction until the tire is lowered to the ground.
5. Take hold of wheel/tire and pull wheel/tire from under the recreation vehicle as far as possible
6. Some looseness must be left in the cable so that the hoist lift plate (metal part of hoist assembly under wheel attached to hoist cable) can be disengaged from the wheel/tire assembly.

To Attach Hoist Lift Plate to the Wheel/Tire Assembly:

1. Place wheel/tire close enough to vehicle for hoist cable lift plate attached to reach center of wheel/tire. (Wheel must be positioned so that the raised portion of the rim is up.)
2. Fold cable over on the lift plate if necessary and insert through the hole in wheel. Make sure lift plate is all the way through wheel.
3. Pull wheel/tire rearward, away from the recreation vehicle so that hoist cable is taut/tight and lift plate has wheel opening resting on the steps of the lift plate.

To Raise and Stow the Wheel/Tire Assembly:

1. Insert the driving tool into hole in rear of vehicle, or access to driving feature for hoist, and push in until engaged in the driving feature of hoist. This may be a hex on end of a drive extension tube, or an actuator feature on the end of the hoist drive shaft.
2. Rotate drive tool clockwise until wheel/tire assembly is pulled under vehicle, and is pulled up against bottom of vehicle.
3. Continue to rotate in the clockwise direction until at least two crisp breaks are felt, and or clicks are heard. This “stows” the wheel/tire, by forcing the hoist up through an “overload” condition.
4. Replace travel nut on spare tire.

Spare Tire Flip Down Style Tire Carrier

⚠ WARNING

Do not lie under the carrier when retrieving the spare tire as the carrier will flip downward.

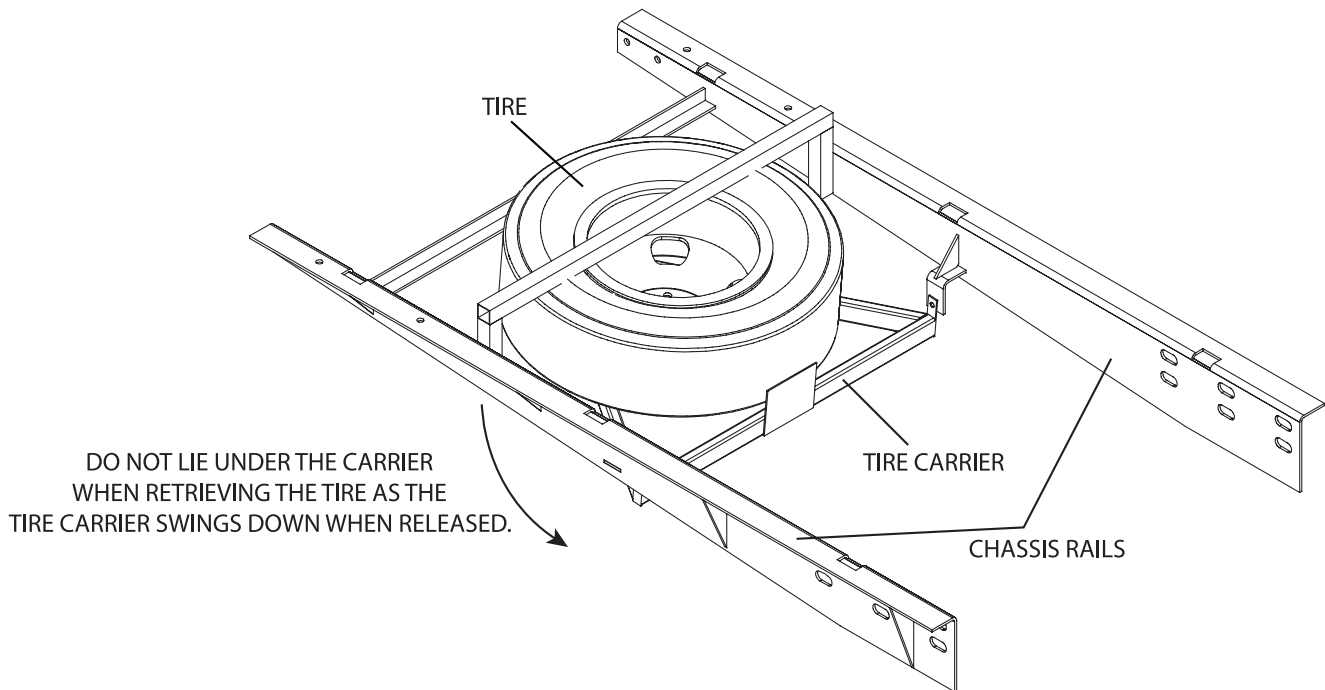

To Lower Spare Tire

1. Locate the spare tire under the chassis frame just in front of the trailer hitch.
2. Using either a 9/16" or 3/4" wrench (depending on model), loosen the bolt(s) that hold the spare tire carrier up. This will allow the rear of the carrier to pivot toward the ground.

NOTE: On some models it may be necessary to completely remove the nut(s) in order to remove the spare tire.

3. Once the carrier is lowered, slide/pull the spare tire off of the carrier.

To Raise Spare Tire

1. Slide the tire up and onto the tire carrier.
2. Using either a 9/16" or 3/4" wrench (depending on model), tighten the J-bolt nut(s) on the tire carrier. Doing so will compress the tire in the carrier for a tight fit. The tire needs to be compressed tightly, as failure to do so could result in the tire sliding off of the carrier.
3. Get the flat tire repaired as soon as possible.

NOTE: Replace the locking nut(s) on the J-bolts with new ones of appropriate size and quality.

TRAILER TOWING

WARNING

A separate functioning brake system is required for any towed vehicles or trailers weighing more than 1000 lbs when fully loaded. NEVER exceed the GVWR, or the GAWR specified on the recreation vehicle certification label. Also NEVER exceed the weight ratings of the trailer hitch installed on the recreation vehicle. Failure to heed any part of this warning could result in loss of control of the recreation vehicle and towed vehicle or trailer and may cause an accident and serious injury. For specific towed vehicle braking requirements, consult the chassis owners manual.

NOTICE

The recreation vehicle fully loaded and the trailer, or towed vehicle, must not exceed the recreation vehicle chassis' Gross Combination Weight Rating (GCWR). Consult with your selling dealer to determine the GCWR of the recreation vehicle. Do not exceed the recreation vehicle Gross Combined Weight Rating (GCWR) or the hitch rating. The tongue weight, the weight pushing down on the hitch, must not exceed 10% of the hitch capacity.

Always use safety chains between the recreation vehicle and the towed trailer or vehicle. Cross chains under the trailer tongue and allow slack for turning corners. Connect safety chains to the trailer or vehicle frame or hook retainers. Never attach chains to the bumper of a vehicle.

Tow bars or car dollies generally are made to travel in a forward direction only. Most towing equipment of this type is not designed for backing. Never attempt short back up distances with a tow bar or tow dolly. Damage to the recreation vehicle, towed vehicle or towing device will result.

NOTE: Four Winds International accepts no responsibility for damage to the chassis and other components resulting from towing loads greater than its designated class specifications. Also consider the gross combined weight rating of the recreation vehicle before towing a trailer or vehicle. Towing an object such as a boat and trailer or a vehicle behind the recreation vehicle results in added driving considerations that you must contend with.

TOWING PROCEDURES

WARNING

Due to multiple variables that exist in towing the recreation vehicle, operating/positioning the lifting and towing device is the sole responsibility of the tow vehicle operator. The operator must be familiar with standard towing industry safety measures. Improper procedures could result in personal injury or death.

Never allow anyone to go under a recreation vehicle while it is being lifted by towing equipment unless the disabled recreation vehicle is adequately supported by safety stands.

CAUTION

Never tow the recreation vehicle at a speed greater than 50 mph. Never allow anyone to ride in the recreation vehicle while it is being towed. Make sure to review the chassis owner's manual for any additional requirements or cautions concerning the towing of the recreation vehicle.

Do not tow the recreation vehicle from the rear. Towing from the rear will severely overload the front tires and suspension possibly resulting in tire and/or front suspension failure. Rear frame extensions are not designed to support weight loads imposed by lifting the recreation vehicle from the rear.

NOTICE

In case the recreation vehicle requires towing, ensure all precautions are followed. The drive shaft must be disconnected and the mud flap may need removed. The manufacturer WILL NOT cover damage to the recreation vehicle caused by a towing company.

If the recreation vehicle needs towed for service it is recommended to use a lowboy/landall type of trailer. If a tow truck is used it needs to have a support arm that goes under the recreation vehicle and secures to the front axle. Inform the tow company of the axle weights and total weight of the recreation vehicle. Other important information is the length of the recreation vehicle, number of passengers and mile-post location. If the recreation vehicle needs to be towed:

- Review the chassis owner's manual for proper towing guidelines.
- Secure any loose or protruding parts if the recreation vehicle is damaged.
- If the rear wheels are disabled, place the recreation vehicle on a flat bed trailer or use a heavy duty dolly under the rear wheels and tow the recreation vehicle from the front.
- The drive shaft must be removed to prevent damage to the transmission. Secure the end caps to prevent losing or contaminating the needle bearings.
- The rear mud flap may need to be removed to prevent damage due to limited ground clearance.
- Use an approved tow truck normally used for towing large vehicles.
- Tow with the parking brake released and the transmission in neutral.
- Make sure the front wheels are lifted at least four inches off the ground, and that the rear of the recreation vehicle has adequate clearance.

EMERGENCY STOPPING

If an emergency ever requires you to be stopped, be sure to follow these guidelines:

1. Pull off the road as far as possible.
2. Select the Park position on the shift selector and apply the Parking Brake.
3. Turn on the hazard warning flashers.
4. Use three red warning indicators such as flares, reflectors, or lanterns as required by the Uniform Vehicle Code and Model Traffic Ordinance as follows:
 - a. Place the first indicator on the traffic side of the vehicle, directed at the nearest approaching traffic.
 - b. Place the second 100 feet behind the recreation vehicle in the center of the lane and toward approaching traffic.
 - c. Place the third 100 feet in front of the recreation vehicle in the center of the lane and away from the traffic approaching from behind.
5. Always stand off the road.

NOTE: *Curves and/or hills may effect the safe placement of warning indicators.*

ENGINE & DRIVE TRAIN

Full operating and service information may be obtained by consulting the engine and drive train operating and service manuals provided by the chassis manufacturer. For maximum engine efficiency and long service life, always follow recommendations, as outlined by the chassis manufacturer. Regular visual inspections can help detect minor adjustments and needed maintenance. All other components of the chassis should be inspected regularly per the schedules set by the chassis manufacturer.

Engine Cooling System

WARNING

Ethylene glycol is a petroleum derivative which can ignite if exposed to high temperature, such as occurs on an exhaust manifold. The possibility of ethylene glycol igniting is increased if it is not diluted with water. It is important to properly dilute antifreeze with the proper mixture of water. Make sure to discuss the coolant needs of the recreation vehicle with the chassis engine service representative.

The engine cooling system requires regular, periodic service to operate at maximum efficiency. The condition of the engine coolant, hoses, and clamps should be checked annually. Make sure to follow the cooling system recommendations as outlined in the chassis engine owner's manual. If you notice, or suspect cooling system problems, make sure it receives immediate attention. Proper and safe operation of the chassis engine cooling system and other chassis functions depends on maintaining the vehicle per the instructions and schedules published by the chassis and engine manufacturers.

Engine Access

WARNING

If the engine cover is not seated correctly, exhaust gases may leak into the recreation vehicle, creating a dangerous and potentially lethal situation.

The recreation vehicle engine can be accessed for service from inside the recreation vehicle. The engine cover between the driver and passenger seats can be removed.

When reinstalling the engine cover, make sure that it is seated correctly without obstruction from carpet, floor mats, etc.

FUELING THE RECREATION VEHICLE

Be extremely careful when fueling the recreation vehicle. Always shut off the engine, do not smoke, or use cellular phones and shut off all pilot lights before adding fuel. Fuel spills represent a serious fire hazard, and should be cleaned up immediately. Never restart the engine, or relight pilot lights while raw fuel is present. When weather gets cold or the recreation vehicle has not been used for a while, a fuel anti-gel additive will be needed.

For your convenience there may be two fuel fills on the recreation vehicle. If so equipped, they are located on both sides of the recreation vehicle, towards the front of the unit. This allows access into filling stations from either side of the recreation vehicle.

NOTE: *If you should lose your fuel cap, it should be replaced as soon as possible, with a cap of the same type.*

NOTE: *Always remove the fuel cap slowly and pay close attention to the fuel recommendations outlined in the chassis literature.*

Ford Fuel Pump Collision Shut-off Switch

If your recreation vehicle is involved in a collision, it is possible that an inertia switch in the fuel pump circuit will open, shutting down the flow of fuel to the engine. This is a safety feature designed to help keep raw fuel from spilling out and creating additional danger. When this inertia switch has been tripped, it is necessary to manually reset it before the recreation vehicle can be restarted and moved. Review your chassis owner's manual for the location of the switch and instructions for resetting.

TRAVEL PREPARATION

Chassis Checks

Like any vacation trip, pre-planning will pay big dividends. In addition to routine trip preparations such as having newspaper delivery stopped and mail held at the post office, there are now more vehicle-related preparations than there are with an automobile.

- Fluid levels (oil, power steering, radiator, transmission, windshield washer, etc.)
- Belts (tension and condition)
- Battery (electrolyte level if applicable, connections, charge)
- Hoses (clamps tight, condition, leakage)
- Seals, gaskets (leaks)

REFERENCE: *Refer to the Chassis Manufacturer's Owner's Manual for more information.*

Exterior Checks

- Tire pressure/condition and lug nut torque
- Headlights, running and safety marker lights including brake and turn signal and also any trailer light connections
- Security of any auxiliary equipment such as TV and awning, etc.
- Windshield wiper blades
- Generator compartment
- Fresh and waste water connections/drains and supplies such as high pressure hose
- Propane compartment/tank

Undercarriage Checks

- Drive train condition, specifically leaks (U-joints, differential, transmission)
- Brakes, including lines, pads/shoes, seals
- Engine area for pan gasket or other leaks
- Anything unusual hanging or tangled with road debris such as tree limbs
- Tank condition (gas, fresh water, waste water)

Operational Checks

- Check operation of all systems, including: Wipers, windshield, horn, brakes, steering, transmission, heater, defroster, air conditioner, and seat adjustment.
- Also idle engine long enough to check cooling system and alternator operation. Be sure to turn on headlights and climate controls to see if alternator handles the additional drain on the electrical system (should not show discharge).

REFERENCE: *Refer to the Chassis Manufacturer's Owner's Manual for more information.*

Pre-Trip Checklist

Pay careful attention to where and what type of flammable materials you store. Certain storage areas are clearly labeled DO NOT STORE COMBUSTIBLE MATERIALS. Examples of spark producing areas, depending on the recreation vehicle model, are: base kitchen cabinets, front dinette base, exterior refrigerator service compartment, as well as refrigerator cabinet. Please use discretion as to what potentially dangerous products your recreation vehicle contains while traveling. Be sure all canisters and bottle tops are secure and leak free.

As an owner you now have the added responsibility to prepare the living quarters for a trip. The following checklist will assist with your preparation:

- Filling fresh water tank. In winter make sure that system is freeze protected.
- Check list of food, utensils and clothing needs.
- Check storage of all items, making sure that everything is secured and that heavy items are stored low so they don't fall.
- Check operation of stove and refrigerator.
- Check paperwork such as owners registration card, vehicle registration, proof of insurance, driver's license and names/phone numbers of individuals you are to contact during the trip, such as ranger stations.

First Short Trips

Our suggestion is to take a weekend trip to a camp location that is close to home. Be sure to have a note pad and pen available to write down items you feel will be needed in the future as well as equipment that you may need to learn more about.

The experience gained from these short trips will assist you in determining the proper supplies and equipment you may need for your first long duration trip. It is understandably upsetting having to purchase a needed item on the road knowing that one is sitting at home unused.

Not all owner's need the same equipment or supplies. For one thing, North America presents a wide variety of climates and terrain. For another, personal needs and taste come into play.

Also, if most of your trips will be made in the summer and your shake down trip is made during some other season, there will be some adjustments to take into consideration. Talk to other owner's and learn from their experiences.

When preparing for your trip always consider vehicle weight when loading the recreation vehicle.

If you are an experienced owner it is still necessary to thoroughly read this manual. New and improved equipment is coming onto the market every day and, at the same time, not every recreation vehicle manufacturer builds vehicles the same way.

INTERIOR CONTROLS & OPERATIONS

DASH CONTROLS

Thoroughly familiarize yourself with the various controls, instruments, and indicators located on the dash. Performance and safety can be enhanced by a driver who fully understands each one, and how to use them.

IMPORTANT: *The dash controls and instrument panels provided within the recreation vehicle are installed by either the chassis manufacturer or Four Winds International. For items not described within this manual, refer to the chassis manufacturer's operations manual.*

NOTE: *The appearance or placement of the gauges, instruments and controls may not exactly match the illustrations within the chassis manufacturer's operations manual however, the instructions for their use will still apply.*

Mirror Control Button

Used to adjust outside mirrors for visibility. Push the side selector left to adjust the roadside exterior mirror, or right to adjust the curbside exterior mirror. Always adjust mirrors for proper vision before starting and moving the recreation vehicle.

Mirror Heat

Activates heating element to defrost the outside rearview mirrors.

ACC (Accessory) Switch

This switch is placed in the dash as a convenience for the owner who wishes to install additional 12 volt functions to the vehicle. It is wired to the fuse block on the front firewall under the hood.

Driving Lights

The driving lights switch controls the on/off operation of the driving lights.

Emergency Start (Optional)

Holding this switch down while turning the ignition switch will allow the auxiliary "house" battery(s) to be used to start the engine in the event the automotive battery is low or dead.

This feature is designed to be used momentarily to start the engine. DO NOT hold the switch down for extended periods of time. Overheating will occur causing serious electrical failure and damage to electrical components.

Generator Remote Start (Optional)

Controls the remote ON/OFF operation of the generator. Refer to the manufacturer's operation manual and read all information regarding the generator operation elsewhere in this manual.

Fans (Optional)

CAUTION

Do not remove the protective cage from the fan. Do not place fingers or other objects into the protective cage.

The fan switch turn the power ON or OFF to the overhead defroster fans. Each fan can be operated separately with individual switches on each fan, if this switch is in the ON position.

DASH RADIO

The dash radio will control the multi-functions for the dash audio system. The tuner holds up to 18 preset FM channels, up to 12 AM channels, and up to 18 Satellite Channels (Satellite Tuner & Service Required). Other features include a CD changer, Cassette Deck, Weather Band, single press mute and comes satellite-ready.

NOTE: *Satellite-Ready means that the in-dash radio will work with a satellite radio tuner, however the satellite tuner and antenna are not installed and must be purchased separately.*

Setting the Clock:

- Press T/F momentarily to change the information displayed by the unit from mode-specific information (radio frequency, CD track number, etc.) to the clock display.
- Press T/F again to return to the default display. The T/F button is also used to set the clock to the correct time.
- Press and hold T/F to enter into clock set mode. When the time flashes on the display, rotate the volume control to adjust the hours. When finished, press T/F again and rotate the volume control to adjust the minutes. When no adjustment has been made for five seconds, the unit will resume normal operation.

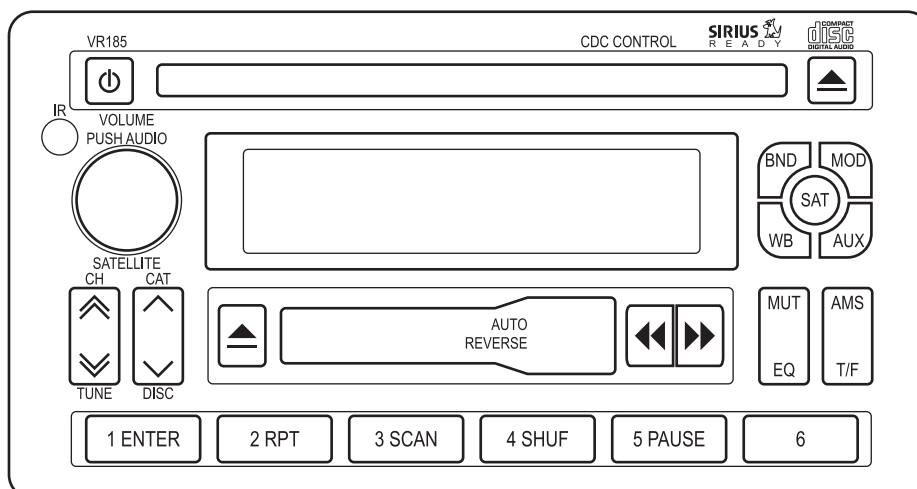

REAR VISION SYSTEM

This system gives a televised view of what is behind the recreation vehicle. It is used as an aid in backing the recreation vehicle, and can also be used for greater field of vision when driving in heavy traffic.

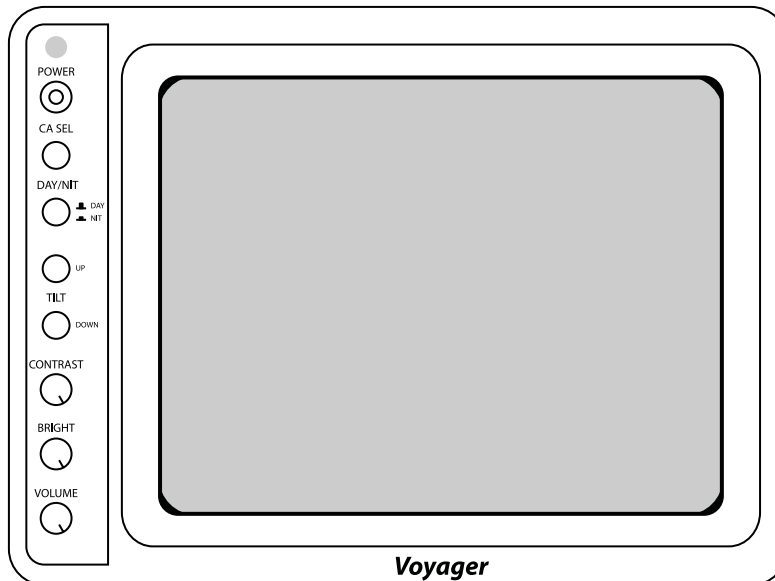

Make sure to check the mirrors when driving and backing, for a more complete field of vision. The camera is equipped with a wide angle lens that can initially present an image that may be deceiving. Make sure to practice backing in a safe place, using the monitor to become accustom to it's operation.

Power Switch:

The power button has two settings, Stand-by and ON. When in the stand-by mode the monitor operates when the recreation vehicle transmission is switched into Reverse. When in the ON mode the monitor system operates when the ignition switch is in the ON position.

NOTE: *The unit will not turn ON when the hazard lights are activated.*

CA SEL (Camera Select Button):

This button is used with the optional side view camera system. Use the button to toggle through the multiple camera views.

Day/Night Mode Button:

Pre-set brightness and contrast levels optimized for day or night operation.

Contrast & Brightness:

Variable controls of contrast and brightness. Should be adjusted if the DAY/NIGHT switch does not achieve the most desirable picture.

Volume:

Variable control of internal speaker volume.

AUTOMATIC HYDRAULIC POWER LEVELERS

DANGER

With any hydraulic application, holding position on a cylinder must be done with safety in mind. Failure in the system may cause the leg(s) to retract or extend on its own. When working under or near the recreation vehicle, always use jack stands of appropriate rating to support the weight of the recreation vehicle.

CAUTION

Read the entire operators manual and all precautions prior to operating this equipment.

Do not use the jacks to change the tires. The system is designed as a leveling and stabilizing system and is not meant to lift the recreation vehicle off the ground.

Do not operate any system functions while anyone is under the recreation vehicle.

Do not attempt to operate the system while the recreation vehicle is in motion.

Never place hands or other parts of the body near hydraulic leaks. Oil may penetrate skin causing severe injury. Wear safety glasses when inspecting or servicing the system to protect eyes from dirt, metal chips, or leaks, etc. Follow all other applicable shop safety practices.

The recreation vehicle should be parked on a fairly level surface. Ensure that there are no obstructions in the extend or retract paths of the jacks. If the surface is soft due to saturation or heat, place boards under the jacks to distribute the weight over a larger area. Using a board which measures approximately 2' wide by 2' in length is recommended. Ensure the front tires are pointing forward and not to the left or right.

REFERENCE: *Refer to manufacturer's operations manual before operating.*

The automatic hydraulic power leveling system allows quick and easy leveling of the recreation vehicle from the driver's seat by utilizing the system touch panel. The following instructions are general operating instructions.

Automatic Leveling & Retraction Procedure

⚠ CAUTION

Make sure there are no obstructions in the extend or retract paths of the jacks.

Keep all people clear of the recreation vehicle while operating the leveling system.

Do not allow excessive motion in the recreation vehicle during the Auto-Level operation. This could cause the system to level improperly.

1. **TURN ON POWER.** The power to the unit must be turned on before any function can be attempted. You need to have the ignition key in the OFF position and the parking brake must be set to turn the control panel on. Push the POWER touch pad to engage power. The power touch pad should be lit when power is on.

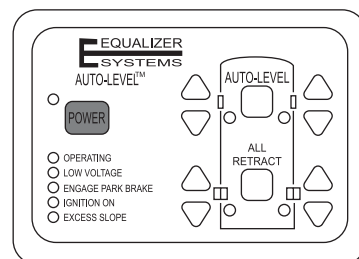

2. **AUTO-LEVEL THE COACH.** Press the AUTO-LEVEL touch pad. The system will automatically level your vehicle. The control panel will send out a series of beeps to let you know that AUTO-LEVEL is operating. When completed, the panel will signal a successful AutoLevel. After ten minutes, the panel will enter sleep mode.

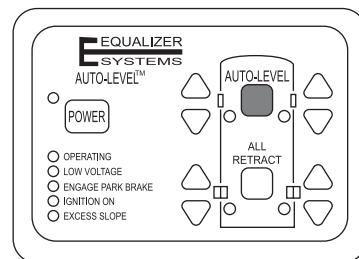

3. **RETRACTING THE JACKS.** Your Equalizer System provides you with the ability to retract the jacks using the ALL RETRACT feature or the UP touch pads for each jack. Press and release ALL RETRACT touch pad. All jacks will automatically retract. The jacks are retracted when all of the LED'S have gone out. Depending on the vehicle, full retraction may take up to 90 seconds.

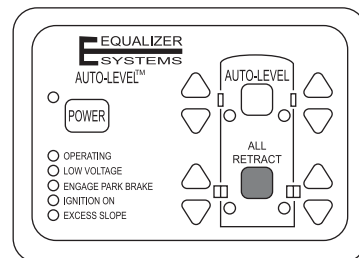

NOTE: The null, or level position has been preset at the factory. However, if you want to change the setting, or if the recreation vehicle has been dormant for more than 60 days you may need to reset the null. Refer to the automatic hydraulic levelers owner's manual for detailed information regarding the proper procedures to do this.

Manual Leveling & Retraction Procedures

⚠ CAUTION

Do not overextend the rear jacks. If the weight of the recreation vehicle is removed from one or both rear wheels, the recreation vehicle may roll forward or backward off of the leveling jacks.

Do not manually overextend individual jacks singularly. This may cause unwanted stress on the recreation vehicle or the jacklegs.

Do not place the recreation vehicle body in a twist while raising or lowering the recreation vehicle. This could cause the windshield to crack or to become loose from the rubber gasket it is mounted in. Do not raise or lower one corner at a time. A complete side, front or rear end should be raised or lowered together to prevent the body from twisting.

1. **TURN ON POWER.** The power to the unit must be turned on before any function can be attempted. You need to have the ignition key in the OFF position and the parking brake must be set to turn the control panel on. Push the POWER touch pad to engage power. The power touch pad should be lit when power is on.

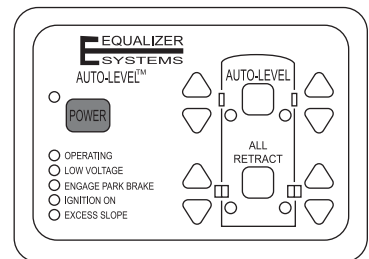

2. **MANUAL LEVEL COACH.** Using the down arrow touch pad, extend each jack, an LED light positioned on the panel will illuminate indicating the jack to be out of the stowed position.

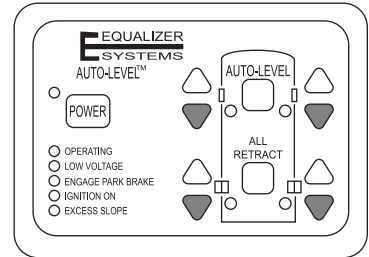

NOTE: Jacks may be operated individually or in pairs as long as they are operated in the same direction.

3. Use a bubble level on a flat surface in the center of the coach as a reference. Level the vehicle by using the DOWN or UP touch pad buttons until the vehicle is level. Jacks may be operated individually or in pairs as long as they are operated in the same direction. Do not attempt to lift the vehicle off of the tires. The panel may be turned off once level has been achieved.

4. **MANUAL LEVEL RETRACTION.** The Equalizer System provides the ability to retract the jacks using the ALL RETRACT touch pad button or the UP touch pads for each individual jack. All jacks will automatically retract and return to stowed position when the ALL RETRACT touch pad is pressed and released. The pump will run in retract mode for 60 seconds to ensure the jacks are fully stowed.

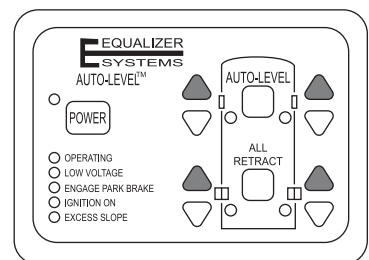

Emergency Retraction Procedure

WARNING

Following manual override operation, failure to return all valves to normal position may result in one or more jack legs drifting down from their retracted (stowed) position. For cartridge valves, rotate the center screw fully counter-clockwise. For directional valves, rotate the red knob until it 'snaps' back to the normal position.

In the event of electrical failure, the jack leg(s) may be retracted manually by following the procedure below.

1. The individual cartridge valves are clustered together on the side of the pump manifold. (They are labeled 1 thru 4 on the diagram on the next page). Locate the screws on the appropriate cartridge valve(s). Using a small flat blade screwdriver, turn the screw(s) clockwise until all the way in*.

*** NOTE:** *The normal operating position of the screw in the cartridge valve is the counter-clockwise 'out' position. The only time the valve should be shifted manually is when attempting to operate jack(s) via manual override.*

2. Locate the red knurled knob on the directional valve** DV2. This valve will be on the opposite side of the manifold from the cluster of cartridge valves. Pull the red knob out and turn 1/4 turn. The knob will remain in the 'out' position.

**** NOTE:** *The normal operating position of the red knob on the directional valve(s) is the 'in' position. The only time the valve should be shifted manually is when attempting to operate jack(s) via manual override.*

3. To retract, locate the red knurled knob on the directional valve**DV1. This valve will be on the adjacent side of the manifold to the cluster of cartridge valves. Pull the red knob out and turn 1/4 turn. The knob will remain in the 'out' position.
4. Remove the black plastic cap from the top of the motor. Use a small flat head screwdriver. Place the drill with the 7/16" (11mm) hex bit on the manual override shaft located at the top of the motor. Run drill in a clockwise direction at 2000 r.p.m. (minimum). The jack leg(s) will retract.
5. When retraction is complete, return the cartridge valve(s) and the directional valves DV1 & DV2 to the normal positions. Reinstall black plastic cap on the motor.

HOSE COLOR IDENTIFICATION

LOCATION	EXTEND (T)	RETRACT (B)
JACK #1 (LEFT FRONT)	Brown	Brown/Black
JACK #2 (RIGHT FRONT)	White	White/Black
JACK #3 (LEFT REAR)	Orange	Orange/Black
JACK #4 (RIGHT REAR)	Yellow	Yellow/Black

B4 = RIGHT REAR JACK (YELLOW/BLACK)
 B3 = LEFT REAR JACK (ORANGE/BLACK)
 B2 = RIGHT FRONT JACK (WHITE/BLACK)
 B1 = LEFT FRONT JACK (BROWN/BLACK)

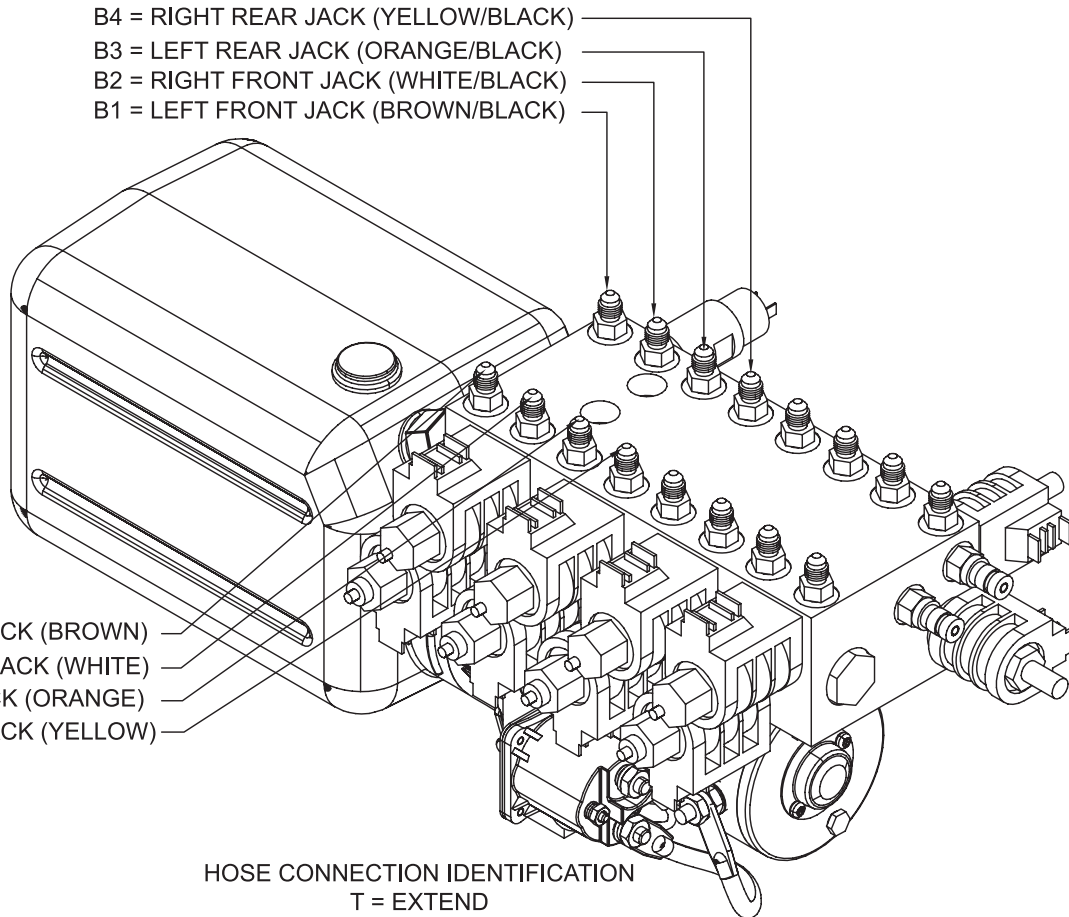

T1 = LEFT FRONT JACK (BROWN)
 T2 = RIGHT FRONT JACK (WHITE)
 T3 = LEFT REAR JACK (ORANGE)
 T4 = RIGHT REAR JACK (YELLOW)

HOSE CONNECTION IDENTIFICATION
 T = EXTEND
 B = RETRACT

SLIDEOUTS

Refer to the manufacturer's operation's manual for complete details and troubleshooting guide.

Hydraulic Slideout

CAUTION

Operating the room with any room-locking device locked can cause personal injury and vehicle damage. It is the operator's responsibility to ensure that all room-locking devices are disengaged before operating the room.

Keep people and obstructions clear of room when operating. The Pilot and Co-Pilot seats must be in their most forward position, with seat backs in the vertical setting.

NOTICE

The recreation vehicle must be level before extending the slideouts.

Perform the slideout room operation with the air suspension system full.

Make sure there is adequate clearance to fully extend the room.

Do not hold the room control switch in the "extend" position for more than ten seconds after the room is fully extended or stops moving. If either side of the room stops moving, release the room control switch immediately.

Extensive damage could occur to the slideout room and awning when extending the slideout room in snow, sleet, ice or freezing rain. In such conditions, if the slideout room is extended, clear the awning and ensure free movement prior to operating the slideout room.

Do not leave the slideout in the extended position during severe weather. Conditions such as high winds or heavy rain may cause damage to an extended slideout.

Debris trapped under the slideout room could result in damage to the floor.

Continuous operation of the slideout could cause a drain on the coach batteries and damage to the slideout motor.

NOTE: *The ignition switch must be in the off position to operate the slideout system.*

NOTE: *Erratic operation of the slideout may be caused by low voltage to the hydraulic pump. Be sure to keep house batteries fully charged to prevent erratic operation.*

NOTE: *Releasing the ROOM CONTROL SWITCH will halt the operation of the room.*

To Extend

1. Level the recreation vehicle.
2. Ensure there is proper clearance to fully extend the slideout.
3. Apply the parking brake and activate the coach battery disconnect switch.
4. Unlock the slideout locks by pressing and holding the the LOCK SWITCH in the “UNLOCK” position.

NOTE: *Rooms with travel locks require both locks to be fully retracted (unlocked) before power to the slideout switch is restored.*

5. To extend the slideout press and hold the ROOM CONTROL SWITCH in the “EXTEND” position. When the slideout is fully extended, release the ROOM CONTROL SWITCH.

To Retract

1. Ensure proper clearance by clearing any obstruction in the slideout area.
2. Apply the parking brake and turn the ignition to the Accessory position.
3. To retract the slideout, press and hold the ROOM CONTROL SWITCH in the “RETRACT” position. When the slideout is fully retracted, release the ROOM CONTROL SWITCH.

NOTE: *When retracting slideouts, a delay may be present until the hydraulic pump builds enough pressure to pull the room in. Just continue to press the switch until the room retracts.*

4. Lock the slideout locks by pressing and holding the LOCK SWITCH in the "LOCK" position.

Hydraulic Slideout - Manual Room Retraction Procedure

⚠ CAUTION

Following manual override operation, failure to return all valves to normal position may result in slideout(s) creeping from their retracted (stowed) position. For cartridge valves, rotate the center screw fully counter-clockwise. For directional valves, rotate the red knob until it “snaps” back to the normal position.

In the event of electrical failure, the slideout(s) may be retracted manually by following the procedure below.

1. Locate the hydraulic pump in the front driver’s side compartment bay.
2. The individual cartridge valves are clustered together on the side of the pump manifold. (They are labeled 5 thru 8 on the diagram on the next page). Refer to the “Hose Color Identification” to select the proper cartridge valve. Locate the screws on the appropriate cartridge valve(s). Using a small flat blade screwdriver, turn the screw(s) clockwise until all the way in.

NOTE: The normal operating position of the screw(s) in the cartridge valve is the counter-clockwise “OUT” position. The only time the valves should be shifted manually is when attempting to operate the slideout(s) via manual override.

3. Locate the red knurled knob on the directional valve DV2. This valve will be on the opposite side of the manifold from the cluster of cartridge valves. Pull the red knob out and turn ¼ turn. The knob will remain in the “OUT” position.

NOTE: The normal operating position of the red knob on the directional valve(s) is the “IN” position. The only time the valve should be shifted manually is when attempting to operate the slideout(s) via manual override.

4. Remove the black plastic cap from the top of the motor. Use a small fat head screwdriver. Place the drill with the 7/16” (11mm) hex bit on the manual override shaft located at the top of the motor. Run drill in a clockwise direction at 2000 r.p.m. (minimum). The corresponding slideout(s) will retract.

HOSE COLOR IDENTIFICATION

LOCATION	EXTEND (T)	RETRACT (B)
Slide 1 (Driver’s Side Front)	Green	Green/Black
Slide 2 (Driver’s Side Rear)	Purple	Purple/Black
Slide 3 (Passenger Side Front)	Gray	Gray/Black
Slide 4 (Passenger Side Front)	Red	Red/Black

HOSE CONNECTION IDENTIFICATION
T = EXTEND
B = RETRACT

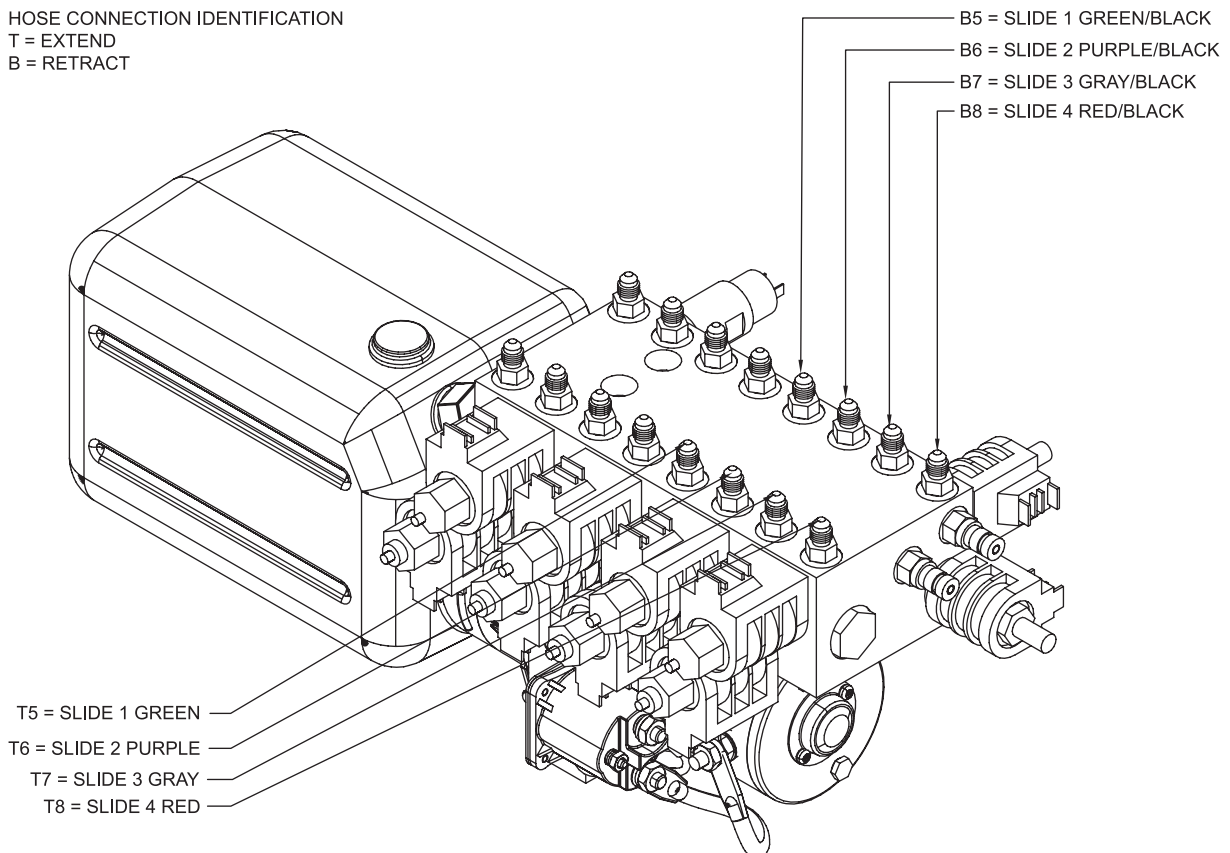

Non-Hydraulic Slideout

⚠ CAUTION

Keep people and obstructions clear of room when operating.

Operating the room with any room locking devices in place can cause personal injury and vehicle damage. It is the operator's responsibility to ensure that all room locking devices (if equipped) are disengaged before operating the room.

NOTICE

The recreation vehicle must be level before extending the slideout room(s). Failure to do so may result in structural damage to the recreation vehicle.

BEFORE EXTENDING OR RETRACTING SLIDEOUT ROOM: Be sure that the driver's seat is in the forward position and the seat-back is straight up. Slideout room will contact chair if chair is improperly positioned.

To Extend

1. Level the unit and unlock all room-locking devices.

NOTE: Make sure that there is adequate clearance to fully extend the room.

2. Apply the parking brake
3. To extend the room, press and hold the ROOM CONTROL SWITCH in the "OUT" position. When the room is fully extended, release the ROOM CONTROL SWITCH.

NOTE: Releasing the ROOM CONTROL SWITCH will halt the operation of the room.

To Retract

1. Make sure to clear any obstruction in the slide-out area, and set the parking brake.
2. To retract the room, press and hold the ROOM CONTROL SWITCH in the "IN" position. When the room is fully retracted, release the ROOM CONTROL SWITCH.
3. Install the room locking devices if equipped.
4. If the room will not retract, refer to the "Manual Retract Procedure".

Non-Hydraulic Slideout - Manual Room Retraction Procedure

NOTE: Only use this procedure when the room will not retract with the room control switch

The room can be retracted manually if an electrical failure prevents the room from being retracted using the ROOM CONTROL SWITCH. For normal retract sequence see the ROOM RETRACT PROCEDURE.

1. Make sure coach disconnect is off and clear any obstruction in the slide out area.
2. Locate the electric motor and gear drive assembly. This may be under a couch, bed, etc. You may also have to remove an access panel if applicable.
3. Depending on the slide mechanism, either a 9/16" or 5/8" wrench will be needed. Rotate the manual override shaft enough to see if it will need to be rotated clockwise or counterclockwise to retract the slide room.
4. Rotate the shaft until the room is retracted fully.
5. The system should be repaired before using again.

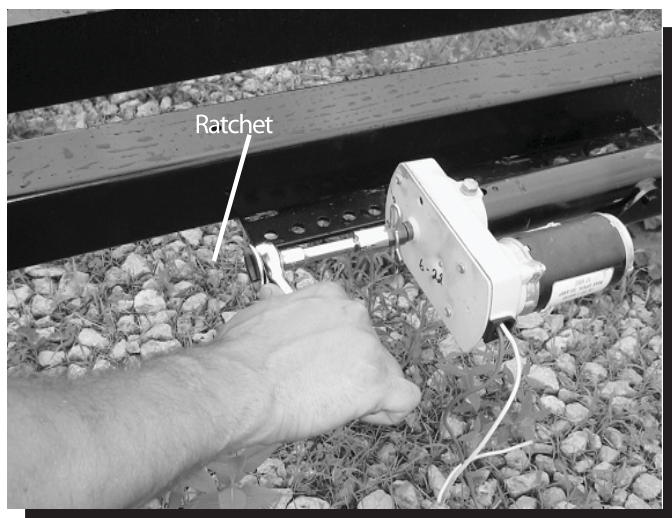
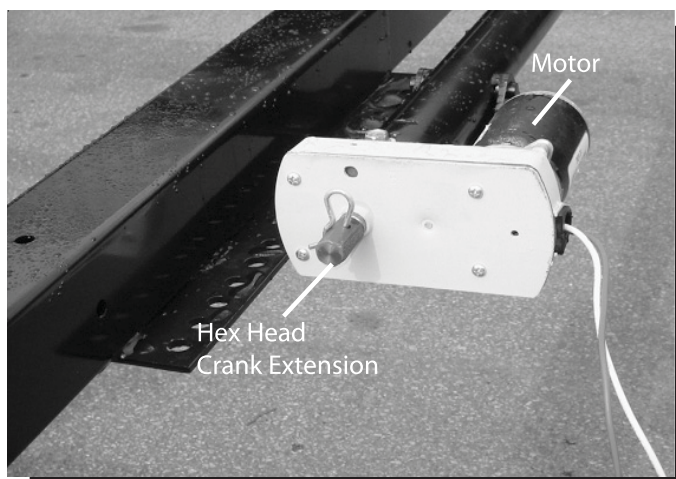

WINDOWS

WARNING

To avoid exhaust gas entry into the recreation vehicle, keep windows closed when the chassis or generator engines are running.

All the windows that open in the recreation vehicle are operated by sliding them back and forth. To operate, pivot the latch to release it from the locked position, and slide the window to open. When closing, slide the window fully closed, and pivot the latch back to the fully locked position. The screens will also slide open and closed if required for an emergency exit.

NOTE: Check window sealant during normal washing and per the Care & Maintenance section of this manual.

DOORS, DRAWERS & STORAGE COMPARTMENTS

WARNING

Make sure before operating the recreation vehicle, that all cabinet doors and drawers are closed, and cabinet contents are secure. Retract and secure sliding doors in the bath area, as well as the bath door, to prevent noise and/or damage while traveling.

Store items in the areas designated for storage. DO NOT store anything in the area reserved for the converter and electrical panels or the water tank and pump.

Cabinet and closet doors in the recreation vehicle have door fasteners, or pneumatic stops, which prevent them from accidentally opening during travel. Drawers throughout the recreation vehicle have travel stops which keep them from sliding out when in motion (under normal driving conditions).

Bed Storage (Some Models)

WARNING

Use caution when lowering the bed to keep hands and fingers at the end ledge provided; and not on the side or further back than necessary, where you may encounter pinch points.

There may be a large storage area located under the bed. It is accessed by grasping the end ledge at the foot of the bed and lifting. Make sure before lifting, that there is nothing on the bed that will restrict its movement, or add extra weight.

Pneumatic struts on both sides of the storage compartment aid both in lifting, and holding the bed in the upright position. When storing items under the bed, be sure to leave space in the storage compartment for the struts when the bed is closed. When lowering the bed, there will be some resistance felt at first, because of the struts. Be sure to keep both hands on the end ledge all the way down to the closed position to avoid having the bed suddenly drop shut.

FURNITURE

⚠ WARNING

Do not occupy beds or any other seats that are not equipped with safety seat belts while the recreation vehicle is in motion. Do not use a seat belt on more than one person.

The sleeping accommodations in this recreation vehicle are designed for occupancy only while the recreation vehicle is parked. All occupants in this recreation vehicle must be seated at a designated seating position and must wear seat belts at all times while this recreation vehicle is in motion. Failure to do so may result in serious injury.

Safety belts and seats can become hot in a vehicle that has been closed up in sunny weather; they could burn a small child. Check seat covers and buckles before you place a child anywhere near them.

Depending on the model and options selected for the recreation vehicle, seating will include some combination of the following:

Easy Bed Sofa with Drawer

Sofa to Sleeper

- Release the sofa locking mechanism by pushing the black handle, located under the center seat cushion, to the right.
- Pull out on the seat base until the seat base and backrest are flat.
- Fold the seat belts out of the way.

Sleeper to Sofa

- Push the seat base towards the back rest until the locking mechanism engages.
- Position the seat belts for use.

Storage Access (Sofa Only)

- Release the handle latching mechanism located under the center seat cushion along the kick panel.
- Pull the storage drawer out to access stored items.
- To close, push the storage drawer into the sofa until the latching mechanism engages.

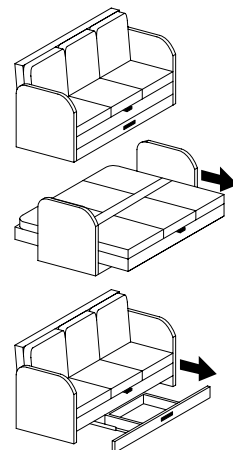

Magic Bed Sofa

Sofa to Sleeper

- Remove the back rest cushions.
- Raise the sofa seat base until the seat base and backrest form a “V” shape by lifting up from the center of the sofa just below the seat cushions.
- Pull out and push down on the seat base until the seat base is flat.
- Fold the seat belts out of the way.
- Flip the seat cushions back to expose the mattress.

Sleeper to Sofa

- Pull the seat cushions back to cover the mattress.
- Lift the seat base up until the seat and back rest form a “V” shape.
- Push back and down on the seat base.
- Position the seat belts for use.
- Replace the back rest cushions.

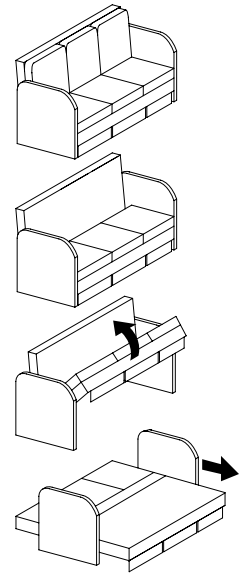

Hide-A-Bed Sofa

Sofa to Sleeper

- Remove the seat cushions.
- Release the lock on the right side of the metal bar, grasp the front metal bar and lift up, pulling out on the bar slightly until the leg of the bed is resting on the floor.
- Fold the seat belts out of the way.
- When the legs of the bed are on the floor another lifting bar will be exposed, grasping and pulling the lift bar will open the bed fully.

Sleeper to Sofa

- Remove all bedding from the hide-a-bed.
- Grasping the foot of the hide-a-bed in the center using the metal lifting bar, lift the front portion of the lifting bar to raise and then lower the hide-a-bed back into the sofa base.
- Position the seat belts for use.
- Replace the seat cushions.

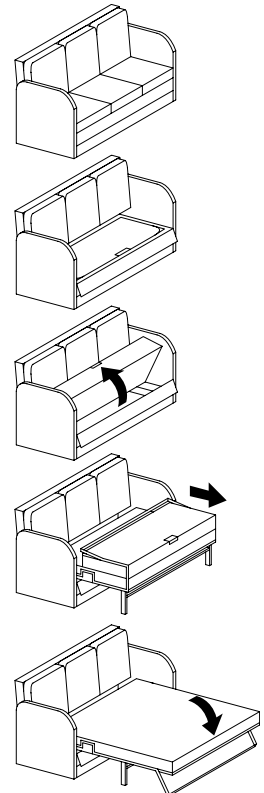

Barrel Chair

The barrel chair has controls on the bottom right and left sides under the chair skirt that controls the swivel and side to side action of the chair.

Euro Recline with Ottoman

To recline, sit down, grasp the armrest's and lean back to recline. Since a seat belt is not provided, do not use the euro recliner while in transit.

Dinette

Booth

The dinette will seat four people. Storage and/or various systems components can be accessed from above by removing the seat cushions and lifting the seat supports.

Free Standing

Since the free standing dinette chairs are not secured to the floor, and not equipped with seat belts, they should not be occupied while the recreation vehicle is in motion. These chairs should be stored securely while the vehicle is in motion.

Pedestal

The dinette can also be converted into an additional bed if required. To convert, lift the table top off of the two support posts. Remove the support posts from the floor and lay them down between the seats. Insert the table top between the seats on the ledges provided. Loosen the seat cushion from the Velcro fasteners and slide each together to form the bed. Reverse this process when reconvert to the dinette configuration.

Wall Mounted

This dinette can also be converted into an additional bed. Lift the aisle side of the table and pinch in the pins on the table leg to collapse the leg. Unhook from side wall and swing into place. The table supports on the dinette base. Loosen the seat cushion from the Velcro fasteners and slide each together to form the bed. Reverse this process when reconvert to the dinette configuration.

Lounge Table

This table is stored in a folded position next to the barrel chair. To raise for use, pull out on the bottom to release it from its securing catch, and swing up. When raised, reach under the table and swing the supporting leg down until it locks into position. Adjust the length of the support leg, so that the table will be level when resting on it. To adjust the support leg length, pull back on the spring clip, releasing the detent from the adjustment hole it is presently in. While holding the spring clip back, slide the leg to the desired length, then release the spring, allowing the detent to lock into the new hole.

To fold back for storage, reverse the previous procedure; shortening the support leg, and folding the leg up against the bottom of the table top. Lower the table top, and push in on the bottom to secure it into the catch that keeps the table from moving while traveling.

Pilot & Co-Pilot Seats

⚠ WARNING

Pilot & co-pilot seats must be locked in a forward facing position with seat belts fastened while the recreation vehicle is in motion. Avoid seat rotation while in transit.

Reclining Back

A control lever on either the left or right sides of each seat controls the reclining angle of the back rest. Lift up on the lever, lean back to position seat angle in the desired location, then release the lever to lock the back rest in place. To return the backrest to the original upright position, lift up on the control lever. It will automatically return to its normal upright position.

Seat Swivel

A control lever on the side of both seats controls the swivel function of the seats. Push the lever forward to release the detent on the swing mechanism. Once the lock is released, the seat may be rotated either left or right to any position.

Forward & Back Adjustment

The forward and back sliding action of the seat is controlled by a lever on the lower left side of the seat. To adjust, pull the lever outward to release the latch, and slide the seat to the desired position. Make sure the seat locks into the position you have selected.

Arm Rests

Arm rests are provided on both the left and right hand sides of the driver and passenger seats. They may be rotated up and out of the way when not required.

NOTE: *Sometimes it may be necessary to adjust the sliding position of the seat and the tilt of the back, to enable the seat to be rotated without obstruction from sidewalls or items to the rear. Some models may not allow complete seat rotation.*

EXTERIOR CONTROLS & OPERATIONS

The following instructions are for items on the outside of the recreation vehicle. Instructions for the operation of appliances and conveniences not found here may be found in other sections dealing directly with appliances and systems. Check the index for the location of specific information.

ENTRY DOOR

The entry door consists of both an exterior door and a screen door used for ventilation when the recreation vehicle is parked.

DO NOT attempt to drive the recreation vehicle with the doors open. DO NOT drive the recreation vehicle with the outer door open and the screen door closed. The doors may be damaged, and it is a safety hazard.

When driving, it is a good idea to keep the door locked to prevent uninvited entrance from the outside when stopped. Two types of locks may be provided with the outer door. The handle lock for normal security, and a dead bolt lock for additional security. The deadbolt must be locked while driving.

The screen door can be attached to the outer door. A sliding panel on the screen door permits access to the handle on the outer door to prevent unnecessary handling of both doors.

Separate keys are provided for both types of door locks. It is a good idea to keep a record of the key numbers in a safe place, should it become necessary to have duplicate keys made.

ENTRY STEP

WARNING

Make sure before exiting the recreation vehicle, that the step is extended. Due to the height of the recreation vehicle, you may accidentally slip or fall if attempting to exit without use of the step. If the step will not operate, use extra care when exiting. Be sure to keep hands, away from pinch points when extending or retracting the entry step.

NOTICE

If the recreation vehicle is driven with the step in the extended position, there is the possibility of causing major damage to both the step and the recreation vehicle.

A manual operating step is provided as standard equipment on most recreation vehicles. To extend the step, lift up on the step and pull towards you. The step is held in place by a detent on each side. To retract the step, lift the step out of the detent, and push back to the original stored position. Make sure that the step is secure in the retracted position before moving the recreation vehicle.

Power Entry Step

WARNING

Make sure before exiting the recreation vehicle, that the step is activated and/or extended. Due to the height of the recreation vehicle, you may accidentally slip or fall if attempting to exit without use of the step. If the step will not operate, use extra care when exiting. Never activate the step when someone is using it, and be sure to keep hands, feet, children, and pets away from the mechanism when activated.

NOTICE

If the recreation vehicle is driven with the step in the extended position, there is the possibility of causing major damage to both the step and the recreation vehicle.

The entry step features amber lighting under the step, and automatic retraction with the ignition key in the ON position. The power switch for the entry step is located on the passenger armrest.

STEP OPERATION:

1. With the entrance door open, turn the override switch to the OFF position. Close the door. The step should retract and lock in the 'up' position.
2. Open the door. The step should extend and lock in the 'down' position with the understep light illuminated.

NOTE: *The understep light operation is as follows:*

- *The light is ON when the step is extended.*
 - *The light is OFF when the step is retracted.*
 - *If the override switch is OFF and the step is extended by opening the door and the door is left open, the light will turn OFF after five minutes.*
 - *The understep light is not available on all step models.*
3. Turn the override switch to the ON position. The step should remain in the extended position with the understep light OFF when the door is closed.
 4. With the override switch turned ON, the step extended, and the entrance door closed, turn the vehicle ignition ON. The ignition override system will go into effect and the step will automatically retract.

NOTE: *If the yellow wire from the four-way connector is not connected to an ignition power source, the ignition safety system will be inoperative and the step will remain in the extended position. In this case, the override switch must be turned OFF for the step to retract.*

5. Turn the vehicle ignition OFF and open the door. The step will extend and lock in the 'down' position. This is the 'Auto Extend' feature. When the vehicle ignition is turned ON, the step will always activate with the door movement, regardless of the override switch position.

STORAGE COMPARTMENTS

CAUTION

When closing the storage doors make sure that hands and fingers are clear of pinch points.

NOTICE

Make sure all compartment doors are completely closed, latched and contents are secure prior to moving the recreation vehicle.

The recreation vehicle is equipped with numerous outside storage compartments. Each door can be locked for security, except for the Propane Gas compartment.

NOTE: *Ensure proper clearance is available for the door to open.*

When storing items within the compartment bays, do not overload them with heavy densely packed items, remember that any weight added to the recreation vehicle affects the overall weight of the vehicle. Ensure that side-to-side weight is comparable to distribute the load evenly.

REAR LADDER/ROOF ACCESS

WARNING

Do not climb on or walk on the roof while wet. The roof could be very slippery causing you to fall, which can result in serious injury or death.

NOTICE

Do not use the roof as an observation platform or storage area, as it is not designed for these purposes.

NOTE: *Four Winds International recommends that roof access be limited to service personnel only.*

The exterior rear ladder provides access to the roof for maintenance of the roof and roof mounted items only. When ascending and descending the ladder, ensure the ladder is clear of debris, such as water, ice and other slippery substances. Always wear shoes that provide good traction, and do not wear sandals or other types of slip-on footwear when ascending or descending the ladder.

NOTE: *The rear ladder maximum weight capacity is 250 lbs.*

AWNINGS

⚠ CAUTION

If threatening weather approaches, you need to retract all awnings. If the awnings are rolled up wet, open them back up as soon as possible to allow them to dry. Also, do not drive during periods of high winds.

Slideout Awning

The Slideout Topper will automatically open and close as the slideout room opens and closes. Because the awning is level, water may puddle on top of the canopy. As the slideout room is closed and the awning rolls up, these puddles may spill over the sides of the awning.

REFERENCE: For detailed information regarding the Slideout Topper Awning refer to the A&E Systems, Slide Topper Installation & Operating Instructions Manual.

Manual Patio Awning

Extend:

- Release both travel straps (one on each arm, about midway up) by squeezing the travel strap buckle to pull both pieces apart.
- Using the provided awning rod, rotate the Safe-T-Lock lever up to the UNLOCK/OPEN position.
- Hook the awning rod into the pull strap loop securely and pull the awning out. Once extended, slide the pull strap to the right and wrap the strap around the awning arm.

NOTE: Prior to closing, remove tie downs and screen if used. Ensure that the travel strap and buckle are clear of the back channel.

Retract:

- Unwrap the pull strap from the awning arm and slide it slightly to the left.
- With one hand, firmly grip the awning pull strap and gently pull down, while at the same time, using the awning rod to rotate the Safe-T-Lock to the UNLOCK/CLOSE position.
- While holding the pull strap firmly, hook the awning rod into the pull strap loop and slowly allow the awning to retract, controlling the speed with the awning rod in hand.
- Once the awning has fully retracted, reconnect the travel straps and tighten by pulling on the loose end of the strap.

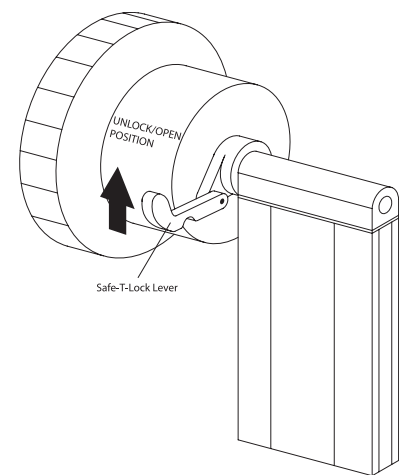

Automatic Patio Awning

⚠ CAUTION

In the event of power loss or awning motor failure the Automatic Patio Awning can be retracted as explained below. If you do not feel comfortable performing this procedure, contact the nearest authorized service center for assistance. Do not drive the recreation vehicle with the awning in the extended position.

Extend:

- Press and hold the remote switch (located on the front of the passenger arm rest) in the extend position until the awning is fully open or utilize the remote control.

NOTE: *Do not press more than one "EXTEND" button at the same time. Awning will not work and/or may cause control box fuse to blow.*

Retract:

- Press and hold the remote switch in the retract position. When awning is fully closed release the switch.

NOTE: *Do not press more than one "RETRACT" button at the same time. Awning will not work and/or may cause control box fuse to blow.*

NOTICE

The awning must be serviced by a Dometic Service Center or a qualified service technician before attempting to open the awning after this procedure has been performed.

Manually Closing the Automatic Awning:

- Two people will be needed to perform this procedure.
- Slide the provided pull strap into the utility slot of the Fabric Roller Tube Assembly.
- Make sure that one person is securely holding onto the pull strap, while the other person removes the bolt in the top of the right top casting. Once the bolt is removed the FRTA will want to roll in on its own. This is why it is very important to hold the strap securely.
- While holding the strap, let the FRTA slowly retract until it is in the closed position.
- Once the awning is in the closed position, align the hole where the bolt was removed and reinstall to secure the awning. The bolt must be reinstalled to prevent the awning from opening during travel.

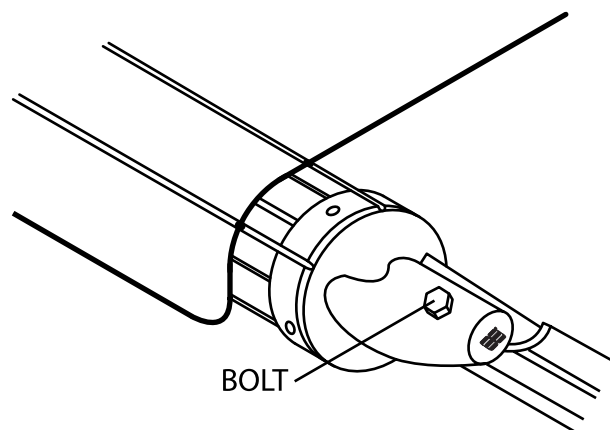

GARAGE AREA (FUN MOVER)

⚠ DANGER

Any motorized vehicle or any motorized equipment powered with flammable liquid can cause fire and explosion or asphyxiation if stored or transported within the recreation vehicle. To reduce the risk of fire, explosion or asphyxiation:

- 1. Do not allow passengers to ride inside the internal combustion engine vehicle storage area while vehicles are present.*
- 2. Do not allow occupants to sleep in the vehicle storage area while vehicles are present.*
- 3. Doors and windows in walls of separation (if installed) must be closed while vehicles are present.*
- 4. Run fuel out of engine after shutting off fuel at the tank.*
- 5. Do not store or transport supplementary motor fuel within this vehicle.*
- 6. Ventilate the interior of the vehicle to reduce the risk of fire, explosion or asphyxiation.*
- 7. Do not operate gas appliances, pilot lights, or electrical equipment when motorized vehicles or motorized equipment are inside the vehicle.*
- 8. Do not operate motorized vehicles while the rear door is closed.*

Failure to comply could result in an increased risk of fire, explosion, asphyxiation, death or serious injury.

Loading an internal combustion engine or other materials inside of cargo storage area will affect the weight distribution of the recreation vehicle. Adding weight to the unit behind the rear axle will reduce weight to the front axle. This may adversely affect handling of recreation vehicle while in transit. Adding the weight behind the rear axle also adds to the weight load on the rear axle. Do not over load the rear axle weight rating.

Cohabiting with an internal combustion engine vehicle can be hazardous to your health. Fumes from fuel can cause fire, explosion, or asphyxiation.

Liftgate

DANGER

This is not a personnel lift. Do not stand on or near lift when in motion. Serious injury or death may occur.

CAUTION

Keep all personnel clear of platform working area while raising, lowering or unfolding.

Keep all objects clear of pinch points when raising platform.

Do not operate this gate without cover installed.

Refer to the liftgate manufacturer's operations manual for detailed information regarding the proper usage of the liftgate.

Fold-Down Ramp

CAUTION

Keep all personnel clear of ramp working area while raising or lowering.

Keep all objects clear of pinch points when raising and lowering platform.

Keep the loading area clean and free of clutter and debris. Keep the ramp and floor dry by cleaning up all spilled water, oil and fuel as soon as possible.

The fold-down ramp gives complete access to the cargo area. When lowered, the ramp allows easy loading of rolling cargo, bicycles, motorcycles, ATV's and other small vehicles.

When loading and unloading always walk items up and down the ramp. Never ride a vehicle or bicycle on the ramp.

Always wear shoes that provide good traction, and do not wear sandals or other types of slip-on footwear when ascending or descending the ramp.

NOTE: Refer to the fold-down ramp manufacturer's operations manual for detailed information regarding the proper usage of the fold-down ramp.

Core-Trax™ Tie-Down System

⚠ CAUTION

Read and follow these instructions carefully. Inspect product before each use. DO NOT USE product if deformed, damaged, or not securely installed. Avoid contact with objects or chemicals that may damage or weaken product. Product is not designed for use as a personal restraint or for towing. User is responsible for determining product's suitability for a particular purpose. Core Marketers Group, Inc. and Four Winds International are not responsible for damage or injury caused by improper use of products.

The correct method for securement of an ATV or motorcycle is to use two ratchet straps in front and two on the rear. Additionally the front wheel must be chocked. The trax are not intended nor designed to control the gravitational forces applied during stopping, turning or accelerated loads.

Load Testing: Direct pull of Load Lock in the Core-Trax™ tie-down system: (breaking strength) 1,500 pounds per Load Lock.

NOTE: *When possible attach the load lock(s) nearest the mounting hardware. This will allow for the safest use.*

Working Load: Maximum cargo weight a tie-down can safely be used for.

Breaking Strength: Maximum tested cargo weight a tie-down can handle before partial or complete failure. The industry standard calculation for Working Load is 1/3 of the Breaking Strength. I.E. Core-Trax™ with a combine Trax/Load Locks tested breaking strength of 1,500 lbs. has a Working Load of 500 lbs. per Load Lock.

Wheeled loads; use a combination of wheel chocks and set brakes in conjunction with the use of all tie-down product.

Selecting Proper Tie-Downs

- Use two (2) minimum 500 lb. Working Load* tie-downs per motorcycle up to 500 lbs.
- Use four (4) tie-downs for ATV's and motorcycles weighing 500 to 1,000 lbs.

Add two more for every 500 lbs. thereafter (Core-Trax uniquely supports this method by making available multiple locking positions).

For other applications, a good rule is that each tie-down should have a Working Load equal or greater than the weight of the cargo. Wheeled loads; use a combination of wheel chocks and set parking brakes in conjunction with the use of all tie-down products.

NOTE: **These are only suggestions; please contact your local department of transportation for their recommendations.*

To obtain warranty service for the Core-Trax product, please call (951) 699-1618. Proof of purchase is required. Shipping expenses are the buyer's responsibility.

HEATING & AIR CONDITIONING

DASH PANEL HEATER/AIR CONDITIONER

The air conditioning system contains refrigerant 134a under high pressure and should be serviced by qualified personnel only. Improper service methods could cause serious personal injury.

The recreation vehicle is equipped with an integrated heating/air conditioning system. While this system is much more powerful than those used in passenger cars, it is not capable of heating and cooling the entire recreation vehicle. This system is designed to provide windshield defrost as well as heating and cooling for the front seat occupants only. By following the operating instructions and tips, this heater/air conditioner will provide many years of comfort and dependable service.

The heater/air conditioner unit is located beneath the dash on the passenger side of the vehicle with heating and cooling coils located on the outside of the firewall. In most modes of operation the unit takes fresh air from outside, and heats or cools it before discharging into the recreation vehicle. Only when operated in the MAX A/C mode does the system take air from inside the recreation vehicle.

Control Panel

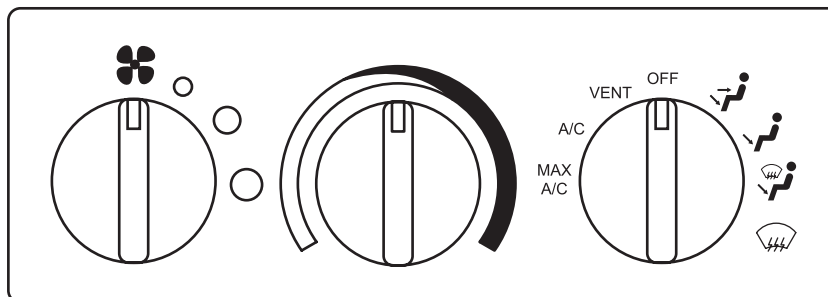

A/C CONTROL PANEL

The control panel enables the driver to control the temperature, volume and direction of the air discharged from the heating/air conditioning system.

One of the best ways of controlling temperature is by changing the speed of the blower. The blower knob (left of center) provides 4 speeds in any mode except OFF. The center knob controls the temperature of the discharge air. Turn the knob to the right (red area) for warmer air, and to the left (blue area) for cooler air.

Operating Features

The air conditioning system is designed to operate in all modes except VENT, FLOOR and OFF. This provides significant moisture, dust and pollen removal for enhanced passenger comfort. Use MAX A/C and HI blower for quick cool down. A lower blower speed produces cooler air. To assist with cooling, close all windows and vents to hot, humid outside air.

NOTE: The A/C will not function if the outside air temperature is below approximately 40° Fahrenheit.

NOTE: In the event control vacuum is lost, the system is designed to discharge through the defrost vents.

Air Distribution - Mode Control

To achieve the maximum comfort in the recreation vehicle, the air must be directed where it is needed. The mode switch (right of center) gives the driver the ability to select where the air will flow.

MAX A/C Air is drawn from the passenger compartment (Recirculated Air) and discharged through the dash louvers. These louvers can be adjusted for maximum comfort. This setting should be used to reduce interior humidity.

A/C Outside air (Fresh Air) is drawn into the system and discharged through the dash louvers.

VENT Outside air is drawn into the system and discharged through the dash louvers. For enhanced passenger comfort, upper-level ventilation air is also discharged through the defrost opening.

OFF The blower motor does not operate in this mode. The fresh air inlet door closes, minimizing outside air infiltration into the vehicle.



Outside air is drawn into the system and discharged through the dash louvers, floor and defrost outlets. The A/C system operates in BI-LEVEL mode.



Outside air is drawn into the system and discharged through the floor outlets. In some models a small amount of air is directed to the windshield for defrost. The A/C system does not operate in FLOOR mode.



Outside air is drawn into the system and discharged through the floor and defrost outlet. The A/C system operates in MIX mode to provide windshield defogging.



Outside air is drawn into the system and discharged through the defrost outlets. The A/C system operates in DEFROST mode to provide windshield defogging.

NOTE: The discharge air will heat up faster if the blower is operated on lower speeds, until the engine is hot. For windshield de-icing use DEFROST mode.

Keep the condenser and radiator free of bugs and debris. During periods of little use, operate the A/C system monthly to keep the compressor lubricated. Periodically inspect belts and hoses for wear and proper tension.

Warranty/Service

If repairs are necessary during the terms of the recreation vehicle warranty, please contact the nearest authorized Four Winds International dealer for service. In the event repairs are necessary during transit, contact Four Winds Customer Service. Certain individual parts of the Heating and Air Conditioning System such as the compressor, dryer and condenser are covered under the chassis manufacturer warranty.

NOTE: *Components covered under the Four Winds International Limited Warranty must be Original Equipment Manufacturer (OEM) parts. The installation of after market components, or unauthorized repairs may void the warranty.*

ROOF MOUNTED AIR CONDITIONER

The recreation vehicle is equipped with a roof mounted air conditioner. This air conditioner operate from 120 Volt AC only, either from shore power or the on-board generator. Air conditioner functions are controlled by the comfort control panel.

Performance Characteristics

You can expect to see up to 18 to 20 degree differences in temperature between the closest A/C outlet vent and the return air inlet grill under most operating conditions.

Factors that can affect the performance of the cooling system:

- Use window and patio awnings when outside ambient temperature is above 95° F to help deflect the Sun load during the heat of the day. If window awnings are not installed then use shades or blinds to deflect the Sun.
- Try to avoid using the cooktop or oven when the ambient temperature is over 95° F.
- Keep windshield covered when facing the afternoon Sun when parked.
- The number of windows within the slideouts and the number of cold air registers to handle heat gain when facing the afternoon Sun.

Return Air Filters

NOTICE

Do not use harsh chemicals or solvents to clean the filter.

Clean the return air filters as needed for the environment in which they operate. The return air filters are inside the air intake vent covers located on the recreation vehicle ceiling. Never operate the air conditioners without the return air filters in place. Doing so may result in the build-up of dirt on the evaporator core affecting the performance of the air conditioner.

To Clean:

- Remove the vent cover and filter.
- Wash the filter and cover in warm soapy water.
- Rinse the filter and cover thoroughly with fresh water. Allow to dry.
- Reinstall the filter and cover.

FURNACE

⚠ CAUTION

This appliance is equipped with an electric ignition device which automatically lights the burner. Do not try to light the burner by hand.

The furnace and all related components are 12 Volt DC operated, using propane as the fuel source.

The following items must be done for the furnace to operate.

1. The propane tank must be filled and the house batteries should be fully charged.
2. The propane valve located on the propane tank must be in the open position. The valve should only be opened or closed by hand. If the valve cannot be turned by hand, have the valve checked by a qualified service technician.
3. All power to the appliance should be on. Breakers and 12 Volt fuses are located at the foot of the bed.
4. Set the thermostat to the desired function and temperature setting.

REFERENCE: *For detailed information regarding the Furnace refer to the manufacturer's operating instructions manual.*

THERMOSTATS

Depending on the model of recreational vehicle and the options selected the thermostat's in your recreational vehicle may not look exactly as the ones shown here.

Certain roof mounted air conditioners have self contained thermostats and controls which are located at the return air grill.

REFERENCE: For detailed information regarding the thermostat refer to the manufacturer's operating instructions manual.

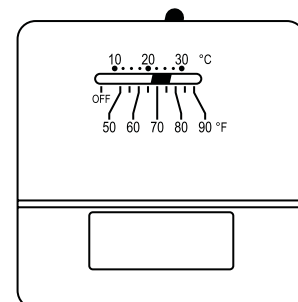
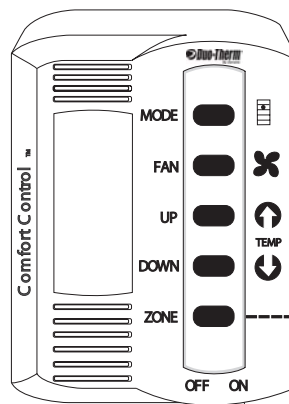
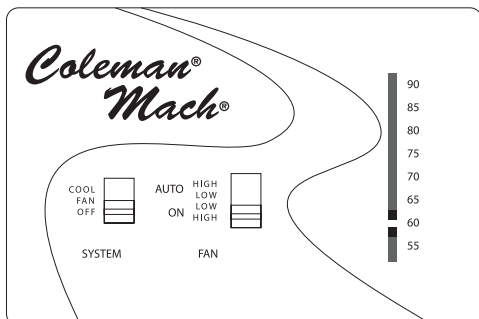

CEILING VENTS

Vents are provided in the recreation vehicle to circulate fresh air and exhaust odors.

Exhaust Vent

The power vent has dual controls to operate both opening and closing, as well as the fan. A hand crank controls opening and closing and adjustment of the vent cover, while a push button turns the exhaust fan ON and OFF. Make sure to turn the fan OFF before closing the vent. Also be sure to remove any debris that falls into the vent that may restrict operation.

NOTE: For best results, close all other roof vents and open one window, or door the greatest distance from the exhaust vent.

NOTE: The dome must be open prior to operating the fan motor.

NOTE: Refer to the "Care & Maintenance" section of this manual for proper long term storage procedures.

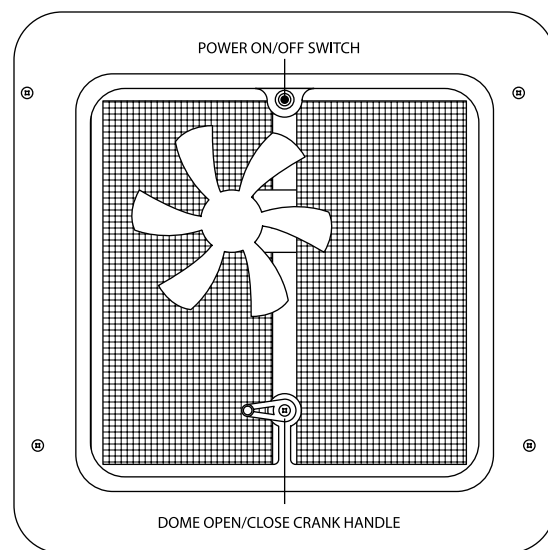

Attic Fan

The attic fan is a three-speed fan which can extract air from the recreation vehicle. To operate the fan use the following guidelines:

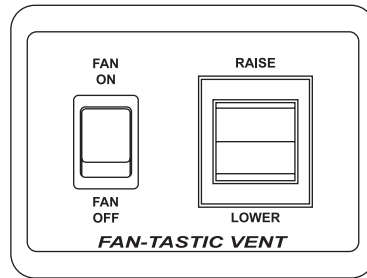

- Turn the wall switch to the ON position, 12 Volt DC power is required for the fan to operate.
- Open the dome approximately 3" or more, by pressing the RAISE/LOWER switch, or by turning the Manual OPEN/CLOSE knurled knob. The fan has a built in safety switch that will not allow the motor to operate unless the dome is partially open.
- Turn the fan speed control dial to the desired performance level (0 - Off, 1 - Low, 2 - Medium, 3 - High). By selecting the "0" setting, the fan acts as a vent only.
- Open a window or door for airflow.

NOTE: For best results, close all other roof vents and open one window, or door the greatest distance from the vent ceiling fan.

NOTE: Refer to the "Care & Maintenance" section of this manual for proper long term storage procedures.

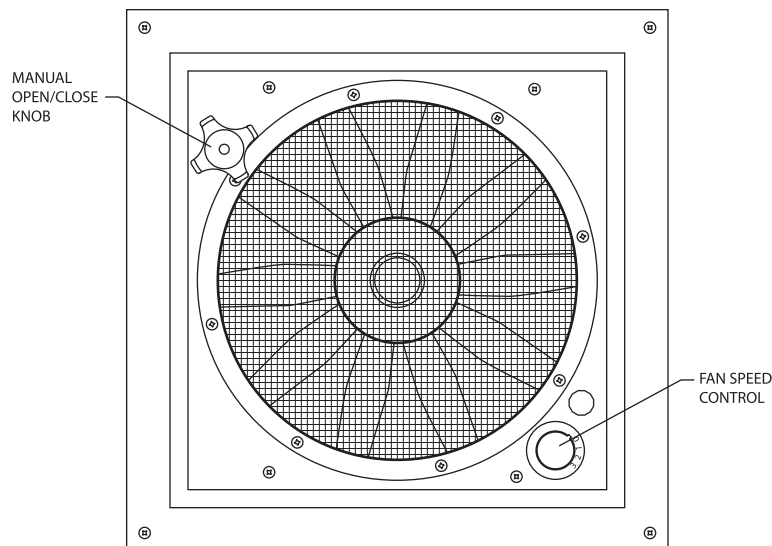

ELECTRICAL SYSTEMS

NOTICE

The electrical system is engineered and tested for safety. Circuit breakers and fuses protect the electrical circuits from overloading. If you plan to make modifications or additions to the electrical system, Four Winds International strongly recommends consulting a certified electrician for assistance to ensure continued integrity and safety of the electrical systems. Please note that any modifications may void the Limited Warranty.

The electrical power supply provided for the recreation vehicle is a dual system, operating with 120 Volt AC and/or 12 Volt DC. The 120 Volt power may be provided by either connecting the recreation vehicle to an outside power source when parked, or by use of a recreation vehicle generator. When the 120 Volt system is operational, power also passes through a system converter, allowing the full use of all 12 Volt functions in the recreation vehicle.

120 Volt appliances in the recreation vehicle include the refrigerator, ice maker, roof mounted air conditioner(s), TV's, DVD player, microwave oven, converter and the water heater. The refrigerator also has the option of running on propane gas when 120 Volt power is not available. All other electrical functions in the recreation vehicle are supplied with 12 Volt power.

When it is not possible to access 120 volt power, the 12 Volt system functions can be supplied by the auxiliary batteries. The chassis battery is protected by a battery isolator controller to prevent discharge from excessive electrical consumption when the recreation vehicle is not running. The auxiliary batteries are recharged by the power converter when the recreation vehicle is attached to an outside 120 volt power source, or by the generator when it is running, and by the chassis alternator when the chassis engine is running.

SHORE CORD

DANGER

Connecting the shore cord to a non-grounded or improperly grounded power source can result in dangerous and possibly fatal electric shock. Due to the potential danger in failing to heed this warning, the recreation vehicle manufacturer cannot be responsible should damage, injury, or death result from failure to connect the power cord to a properly grounded power source.

WARNING

If shore power service is limited to 15 or 10 amps, use of light duty extension cords and electrical adapters will create a Voltage loss through the cord and at each electrical connection. Line Voltage loss and the resistance at each electrical connection can be a hazardous combination. Damage to sensitive electronic equipment may result.

30 Amp Shore Power

WARNING

The recreation vehicle is designed to be connected to a 30 amp service which provides 120 Volts. The 120 Volts comes from two separate 60 Volt lines that are in the shore power cord. The recreation vehicle should never be connected to any power source that will provide anything more than 60 Volts on either incoming line. Failure to follow this will result in serious damage to internal items that are plugged in.

A 30 amp shoreline power cord is provided to attach the recreation vehicle to a grounded power source. The electric utility service connection is located on the driver's side of the recreation vehicle near the rear, in various locations depending on the model that you have. The power cord is stored inside the electric utility service compartment. The electric utility service door has a slot with a cover that can be moved to the side, allowing the power cord to be used and the door to be closed and locked for security.

When connecting or disconnecting from a grounded external power source, always turn off the shore power breaker to the power supply outlet. This will prevent accidental shock and flashing of electrical contacts. After connecting the recreation vehicle to the grounded external power source, wait a few minutes for the inverter/charger (if equipped) to stabilize charging of the batteries before starting large AC loads such as the air conditioner.

50 Amp Shore Power

⚠ WARNING

The recreation vehicle is designed to be connected to a 50 amp service which provides a combined total of 240 Volts. The 240 Volts comes from two separate 120 Volt lines that are in the shore power cord. The recreation vehicle should never be connected to any power source that will provide anything more than 120 Volts on either line coming in. Failure to follow this will result in serious damage to internal items that are plugged in.

A 50 amp shoreline power cord is provided to attach the recreation vehicle to a grounded power source. The electric utility service connection is located on the driver's side of the recreation vehicle near the rear, in various locations depending on the model that you have. The power cord is stored inside the electric utility service compartment. The electric utility service door has a slot with a cover that can be moved to the side, allowing the power cord to be used and the door to be closed and locked for security.

When connecting or disconnecting from a grounded external power source, always turn off the shore power breaker to the power supply outlet. This will prevent accidental shock and flashing of electrical contacts. After connecting the recreation vehicle to the grounded external power source, wait a few minutes for the inverter/charger (if equipped) to stabilize charging of the batteries before starting large AC loads such as the air conditioner

NOTE: Shown below are the three types of shore power outlets which are most commonly used throughout the United States.



50 Amp



30 Amp



15-20 Amp

BATTERIES

The chassis and/or auxiliary batteries of a recreation vehicle may be located behind the front hood of the recreation vehicle or in an exterior compartment. This battery is mounted in a battery box with removable lid. To access the battery, remove the screws and lift the top case off. When reinstalling the cover make sure all connections are tight and the lid seals completely when secured to prevent battery fumes into interior of the coach.

It is important to make sure that batteries are kept charged. Take time to turn off all lights or other 12 Volt conveniences when not in use. Connect the recreation vehicle to a 120 volt power supply when possible, instead of draining the batteries. The charge condition of the batteries can be checked with the monitor panel. To check, press and hold monitor test switch while reading the charge level on the battery gauge. Charge levels indicated are divided into sections from weak through fully charged.

Battery Safety

DANGER

BATTERIES CAN EXPLODE! Always wear splash proof safety glasses when working near batteries. Do not smoke or expose any battery to electric sparks or flame. Batteries, when charging or discharging, generate hydrogen. Hydrogen and air is a very explosive mixture.

WARNING

Do not short across the battery terminals. The spark could ignite the gases. Do not wear metal jewelry or a watch when working on a battery.

Before doing ANY work on electrical system, disconnect battery cable and the 120 volt power cord. Do not reconnect the cables until all work has been completed. This will avoid the possibility of shorting or causing damage to electrical components or shock to the servicing person.

Battery electrolyte is a corrosive, poisonous, sulfuric acid. Avoid contact with skin, eyes, clothing, or any painted surface.

Battery Maintenance

WARNING

Sulfuric acid in the batteries can cause severe injury or death. Sulfuric acid can cause permanent damage to eyes, burn skin and eat holes in clothing. Always wear splash-proof safety goggles and gloves when working around the battery. If battery electrolyte solution is splashed in the eyes, or on the skin, immediately flush with clean water for 15 minutes. In case of eye contact, seek immediate medical treatment. Never add acid to a battery once the battery has been placed in service. Doing so may result in hazardous splattering of electrolyte solution.

Battery maintenance is important. Checking the condition of a battery at regular intervals will help insure its proper operation. Here are some recommendations for checking and servicing batteries:

1. Keep the battery mounted securely. Vibration causes early failure of many batteries.
2. Check the electrolyte level of the auxiliary batteries at regular intervals. Keep each cell filled to just above the plates with distilled water. Once the plates have dried out, they cannot be reactivated, and the capacity of the battery is reduced in direct proportion to the area of plate surface that has become dry. This kind of damage can occur quickly; usually it can happen overnight. If the fluid level is low, simply add distilled water.

NOTE: These instructions only apply to batteries other than maintenance-free batteries. Do not open or break seals on maintenance-free batteries.

- While holding a clean hydrometer vertically and wearing splash-proof safety glasses, squeeze the rubber bulb, insert the nozzle into the electrolyte in the cell, and release the bulb. The electrolyte will be sucked up into the barrel or container allowing the float to ride freely. Start with the cell that is closest to the POSITIVE (+) terminal.
 - Squeeze the rubber bulb to release the electrolyte back into the battery's cell.
 - To increase the accuracy of the measurement, in the same cell, repeat this process several times so the float will reach the same temperature as the electrolyte. If you are measuring a large battery, stratification can occur when the more concentrated electrolyte settles to the bottom. If you notice a difference in the readings between the top and bottom of the cell, average the two readings.
 - At eye level and with the float steady, read the specific gravity at the point the surface of the electrolyte crosses the float markings. The specific gravity reading should be between 1.100 and 1.300.
 - Release the electrolyte back into the cell from which it was taken and record the reading. Be sure to avoid spillage.
 - The hydrometer is calibrated at 80° F. Temperature affects the hydrometer reading. The higher the electrolyte temperature, the higher the specific gravity reading. The lower the temperature, the lower the specific gravity reading. Add or subtract four (4) points for each 10° variance from the 80° F chart. Readings between cells should not vary more than 50 "points" (0.50).
 - Repeat the process for each individual cell. The specific gravity reading should not have a difference of more than 30 "points" (.030) between the lowest and highest reading or 10 "points" (.010) below the battery manufacturer's recommended temperature value with the battery fully charged. If so, try and equalize the battery by following the battery manufacturer's procedures. If equalizing does not help, replace the battery. You can determine the battery's state-of-charge by taking the average of the temperature compensated cell readings.
 - Thoroughly rinse the hydrometer with water after using it.
3. Keep the battery clean. Corroded terminals make poor contact and do not allow the chassis alternator or the converter to bring the battery up to full charge. Battery sulfation occurs when the battery has been standing in a discharged condition over a long period of time, or when the battery has been operated continually in a state of partial discharge. Use a baking soda solution to neutralize the acid accumulations on the battery top. Do not allow the soda solution to enter the battery. Make sure the vent caps are secure. Flush with water. Thoroughly dry all cables and terminals, reinstall, and use a plastic ignition spray to protect the terminals.
4. Check the outside condition of the battery. Look for cracks in the case or vent plugs. If the case is cracked, the battery must be replaced. If the vent plugs are cracked, they must be replaced.

5. Watch for overcharging. Three ways to spot overcharging are:

- Active material on the vent cap (heavy deposit of black lead-like material on the underside of the vent cap).
- Excessive use of water.
- By testing voltage regulator output.

6. Make sure the battery hold downs and carrier are kept clean and free of corrosion.

When removing a battery, disconnect the ground battery clamp first. When installing a battery, always connect the grounded battery clamp last.

When a battery needs to be replaced, make sure to replace it with a battery of the same characteristics as the original equipment. Consult your dealer for advice on battery replacement.

Battery Isolator Controller (Class A Recreation Vehicles - Not Available on all Models)

When the recreation vehicle engine is not running, the chassis and auxiliary batteries are kept separated from each other within the electrical system through the use of a battery isolating controller. The controller prevents the auxiliary batteries from discharging the chassis battery when the recreation vehicle is parked.

Some additional characteristics of the isolator system include:

1. Delays connecting the auxiliary batteries to the charging system for approximately 15 seconds, to allow the alternator time to reach full charging ability.
2. After this initial time delay, if the alternator has come up to full charging ability, the isolator will electrically connect the auxiliary and chassis batteries together for charging.
3. If the charging voltage drops below 12 Volts for a period of 4 seconds due to low idle speed and/or excessive load, the isolator will disconnect the auxiliary batteries until the voltage returns to a level of 13.3 volts for about 10 seconds.
4. If the auxiliary batteries are above 11.5 Volts and the chassis battery is below 9 volts, the isolator will automatically provide an emergency start from the auxiliary batteries.
5. In the event the automotive battery is fully discharged, the automatic emergency start feature will not function, it will be necessary to press and hold the start button located on the control box inside the 12 Volt electrical distribution box under the hood or on the dash on some models.

Battery Isolator Controller (Class C Mini Recreation Vehicles)

When the recreation vehicle engine is not running, the chassis and auxiliary batteries are kept separated from each other within the electrical system through the use of a battery isolator solenoid. The isolator solenoid prevents the auxiliary from discharging the chassis battery when the recreation vehicle is parked.

If power is lost to the interior from the auxiliary battery, check the breaker mounted on the side of the isolator solenoid under the hood.

NOTE: *When operating 12 Volt equipment from battery, reduce equipment in use to conserve battery. Gradual dimming of lights, and slowing of motors indicates low battery voltage.*

Battery Disconnect Switch

The battery disconnect switch allows you to easily disconnect the auxiliary batteries from electrical circuits, preventing unwanted discharge during extended nonuse. The switch(s) is/are mounted on a panel near the entrance door.

There are three main uses of the battery disconnect:

1. Prevent unwanted discharging of batteries during extended periods of storage.
2. Prevent shorts or fire hazard while working on the 12 Volt electrical system.
3. Prevent overcharging of batteries if the recreation vehicle is attached to shoreline power for extended periods.

When activating, place the switch for the desired battery system in the ON position. This battery system will now be operational. The disconnect switch must be in the ON position while plugged into shoreline power to charge the battery(s). Place the switch in the OFF position to disconnect 12 Volt circuits.

NOTE: *It is not necessary or advisable to use battery disconnect switches as a substitute for turning off the various 12 Volt applications available in the recreation vehicle.*

NOTE: *If 12 Volt functions are not working, be sure to check that the battery disconnect switch has been placed in the ON position.*

Battery Charging

WARNING

Always wear splash proof safety glasses when working with batteries.

The converter also operates as a battery charger when it is connected to a 120V power source. If the battery is below its full charge, the converter charger will begin operation at a rate that reflects the level of discharge. When the battery is again fully charged, the converter charger drops its charging level back to a maintenance level to keep the battery fully charged.

If for any reason you charge a battery with a source outside the recreation vehicle, make sure to follow the rules of battery maintenance and safety outlined in this section. Also observe these additional safety precautions related to battery charging;

1. Disconnect the battery from the recreation vehicle.
2. Check electrolyte before charging. Be sure each cell is properly filled with distilled water.
3. Make sure to use care when connecting and disconnecting the cables from chargers. A poor connection can cause an electrical arc, which can result in an explosion.
4. Remove the battery vent caps before charging, and make sure that the electrolyte does not splash out as a result of charging too quickly.
5. Check literature supplied by battery manufacturer, and follow warnings or cautions outlined.

POWER CONVERTER

The converter is used to switch 120V electricity from an external supply, or from the generator, to 12 Volt electricity to power interior lights and 12 Volt accessories. The converter requires no maintenance under normal circumstances.

If the converter does not have a 120V supply to convert to 12 Volt, it automatically switches the batteries into the electrical circuit to power 12 Volt functions. When reconnected to a 120V supply, it will again operate from this power source.

The converter will run warm and this is normal. If, however, it gets too hot, it will turn itself off. After it cools down, it will come back on. In most cases, when this happens it is because something has been put around or too near the converter preventing it from receiving adequate ventilation. Make sure not to put anything near the converter that could obstruct ventilation.

A slight hum during operation is also normal for the converter, if you do not have 12 Volt power and no hum, check to see if 120 volt power to the converter has been interrupted.

POWER INVERTER (OPTIONAL)

WARNING

Do not expose the inverter to rain, snow, spray, bilge or dust. To reduce risk of hazard, do not cover or obstruct the ventilation openings. Over heating may result.

The inverter provides 120 volts to the TV and entertainment system and power garage door options if equipped. The inverter will take 12 Volts from the coach battery and convert it into 120 volts. The inverter is controlled by a remote switch panel located next to the coach disconnect switch near the entry door.

NOTE: *Turn the inverter OFF at the remote switch panel to prevent parasitic loads from draining the coach battery when you are not using your recreation vehicle on a daily basis.*

REFERENCE: *For additional information refer to the inverter operations owners manual.*

GROUND FAULT CIRCUIT INTERRUPTER

⚠ WARNING

Even with GFCI protection, persons with severe heart or other health problems may still be seriously affected by an electrical shock. The GFCI outlet is not a substitute for good electrical safety. It DOES NOT protect against contact of the hot and neutral wire at the same time.

The 120 volt outlet in the kitchen and/or bath is equipped with a protective circuit interrupter. The ground fault circuit interrupter (GFCI), is designed to break the flow of current to the protected outlet when an imbalance of current is detected. Imbalances include electrical leakage in an appliance such as a shaver or hair dryer that have developed a weak spot in electrical insulation. The possibility of electrocution exists when using a faulty appliance, while at the same time being in contact with an electrical ground such as water, plumbing, or the earth.

If an imbalance is detected, the GFCI will trip and shut off power to the outlet.

It also does not protect against short circuits or system overloads. Circuit breakers in the main panel which supply power to the circuit, will trip if either of these conditions exist.

The GFCI receptacle should be tested initially when the recreation vehicle is purchased, and at least monthly thereafter.

To test the circuit, use the following procedure:

1. Make sure power is on to the circuit. A test light or 120 volt lamp will work.
2. Push the test button.
3. The red reset button should pop out.
4. All power should be interrupted to outlets protected by the GFCI.
5. Verify by plugging in a light at these outlets, and pushing in the reset button. If the red reset button does not pop out after pushing the test button, or GFCI circuit continues to trip, or if the power is not interrupted to the test light, immediately turn off power at the circuit breaker panel and have a qualified electrician check it out.

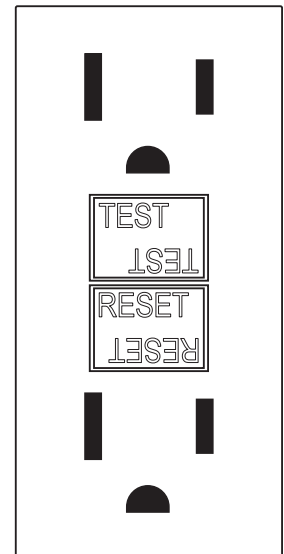

NOTE: *The GFCI does not protect any circuit other than the one to which it is connected.*

CIRCUIT BREAKERS

The 120 Volt system is protected by circuit breakers which automatically shut the circuit off if the circuit load is too heavy, or a short circuit occurs. If a circuit breaker has been tripped, do not reset the breaker until the cause of the problem is identified and corrected.

The generator also has one or two AC circuit breakers, and a DC fuse on the generator control panel. If an interruption in generator operations occurs, check to see if any of these have been tripped. Consult the manuals provided with the generator before attempting maintenance on the generator.

NOTE: *Some electrical appliances may have their own circuit breakers. If there is an interruption in electrical service of an appliance, consult the manual for that appliance to determine what action to take.*

12 VOLT SYSTEM FUSES

Interior

A 12 Volt DC distribution panel is located next to the 120 Volt circuit breakers. The panel contains circuits with replaceable fuses for protection of recreation vehicle 12 Volt lines. If any line is loaded beyond the capacity of its fuse, the fuse will "blow". A portion of the 12 Volt load on the line must be turned off to reduce the total load on the line to a level below the capacity of the fuse. Replace the fuse with the same size fuse. DO NOT replace with a larger fuse than indicated.

If this reduction of load on the line does not stop the "blowing" of the replaceable fuses, there may be a "short" somewhere along the 12 Volt line, or at a non-fused 12 Volt component on the line. Check the 12 Volt line and any components along the line. Locate the "short" and take necessary steps to repair it. If you cannot locate the problem, have a qualified electrician check it out.

It is a good idea to keep additional fuses on hand in the recreation vehicle. Replacement fuses are available at filling stations, hardware stores, or automotive supply stores. Remember that the replacement fuse must be the same amperage rating as the original.

Automotive

Your recreation vehicle chassis is equipped with an automotive 12 Volt fuse panel located below the dash near the steering column and/or under the hood. You should refer to the chassis owner's manual for details on these fuses.

The Class A recreation vehicle also has a 12 Volt fuse panel, electrical distribution box, located on the firewall under the hood. These fuses protect the automotive features which are installed by Four Winds International. There is a complete breakdown on the various fuses printed on the backside of this fuse panel cover.

CHASSIS ALTERNATOR

The primary point to keep in mind about the unit's 12-volt system is that the automotive chassis alternator supplies power to both the automotive systems as well as any auxiliary battery and directly to the RV living quarters while the vehicle's motor is running. Thus, of primary concern to you is the condition of the vehicle's electrical system and especially the alternator.

The alternator compensates for electrical usage in the vehicle, the power drawn by the appliances, lights, fans and other 12-volt powered items as well as the charging of the automotive and auxiliary batteries.

If the alternator isn't keeping pace with the draw on the unit's electrical system, while driving down the road, it means you're working in a negative mode: more power is being used than the unit is putting out.

This means that you are taking power out of the batteries. If you draw too much power from the batteries there may not be enough power left in the battery to start the RV or run any of the appliances when you stop for a break or for the night.

So, always keep an eagle eye on the alternator's output. Also check the monitor panel frequently to see that the auxiliary battery is up to full charge.

The alternator will charge at a higher rate right after the vehicle's been started, replacing the power used to start the vehicle, but the charging should quickly go back to "normal" and hold its own even when you turn on lights or appliances.

When stopped at a campsite that allows you use of the shoreline, the 120-volt electrical system will recharge your auxiliary battery

When checking auxiliary battery condition, turn on several interior lights to place a load on the battery. Under heavy usage in warm weather, check the fluid level of those batteries that require attention to fluids quite often. Low battery fluid level is very harmful to the battery's longevity.

If the alternator shows a discharge while the motor is running, turn off appliances and lights to see if a charge comes on or if the alternator indicates "neutral". Then apply a drain on the system to see if a discharge returns. If a discharge persists, contact your dealer.

GENERATOR

DANGER

Carbon monoxide is poisonous and can cause unconsciousness and death. Follow all instructions in this section as well as the ones outlined in the generator operator's manual.

IMPORTANT: *Make sure to read and understand the generator owner's manual before operating the generator. Observe all operating instructions and warnings as well as all recommended maintenance schedules and procedures.*

The onboard generator allows the recreation vehicle to be fully self-contained. It provides access to 120 Volt A/C when shore power is unavailable, but keep in mind that when in use the generator exhausts deadly carbon monoxide gas! NEVER sleep in the recreation vehicle with the generator running! Before you start and use the generator inspect the exhaust system. Do not use the generator if the exhaust system is damaged. Test the carbon monoxide detector every time you use the recreation vehicle. Know what the symptoms of carbon monoxide poisoning are:

- Dizziness
- Vomiting
- Nausea
- Muscular twitching
- Intense headache
- Throbbing in the temples
- Weakness and sleepiness
- Inability to think coherently

If you or anyone else experience any of these symptoms get to fresh air immediately. Shut the generator down and do not operate it until it has been inspected and repaired by a professional. If the symptoms persist seek medical attention.

1. DO NOT operate the generator while sleeping. You would not be aware of exhaust entering the recreation vehicle, or alert to symptoms of carbon monoxide poisoning.
2. Never store anything in the generator compartment. Always keep the compartment clean and dry.
3. DO NOT operate the generator in an enclosed building or in a partly enclosed area such as a garage.
4. Review the safety precautions for fuel and exhaust fumes elsewhere in this manual.
5. DO NOT operate the generator when the recreation vehicle is parked in high grass or brush. Heat from the exhaust could cause a fire in dry conditions.

6. Never operate the chassis or generator engine, or the engine of any vehicle, longer than necessary when the vehicle is parked.
7. DO NOT simultaneously operate generator and a ventilator which could result in the entry of exhaust gas.
8. When parked, position the recreation vehicle so that the wind will carry the exhaust away from the recreation vehicle. DO NOT open nearby windows, ventilators, or doors into the passenger compartment, particularly those which can be “down wind”, even part of the time.
9. DO NOT operate the generator when parked in close proximity to vegetation, snow, buildings, vehicles, or any other object which could deflect the exhaust under or into the recreation vehicle.
10. DO NOT touch the generator when running, or immediately after shutting off. Heat from the generator can cause burns. Allow the generator to cool before attempting maintenance or service.

The generator draws fuel from the recreation vehicle chassis fuel tank. The fuel supply line for the generator is placed higher in the fuel tank than that of the fuel supply line for the chassis engine, this prevents the generator from draining all the fuel from the fuel tank. The generator on diesel engine recreation vehicles may also be fueled by using propane gas supplied from the onboard propane gas tank.

NOTE: *Some models may require you to plug the 30 amp shoreline into the generator outlet provided in the shoreline storage compartment.*

To start the generator locate the generator start switch, which is located at one of the following locations:

- Generator Control Panel
- Kitchen Base Cabinet
- Remote Dash Switch

WATER SYSTEMS

The recreation vehicle plumbing system has the dual ability to be self-contained with on-board storage, or use facilities provided by an external pressurized source. In either case, the components of the system operate like those in your home. Components of the plumbing system consist of strong, lightweight, corrosion-resistant materials that provide long life, and easy cleaning. By following the instructions outlined here, you can expect efficient operation with a minimum of maintenance.

Recreation vehicle plumbing can be divided into two separate systems. The fresh water system consists of those items which are used to deliver water for your use, while the waste water system is made up of the drains and tanks which store and remove water that has been used.

FRESH WATER SYSTEM

Fresh water is provided from an external pressurized source, or from the fresh water storage tank.

External Hook-up

Water provided from outside the recreation vehicle is pressurized by the system from which it is delivered. When you connect your recreation vehicle to an outside source, the fresh water tank and the water pump are kept separate from the remainder of the system by in-line check valves.

To connect the recreation vehicle to an outside source of water:

1. Remove the cap from the fresh water inlet on the side of the recreation vehicle.
2. Attach one end of the fresh water hose to the outside source of water.
3. Connect the other end of the hose to the recreation vehicle city water inlet.
4. Turn the outside source of water ON. Open the various faucets in the recreation vehicle gradually to clear the air from the lines. Close the faucets when the water flows freely.

NOTE: *Do not turn the water pump on when using water from an external supply.*

To disconnect from the outside source of supply:

1. Shut off the outside source of supply.
2. Disconnect the hose from the supply valve and the recreation vehicle inlet.
3. Re-reel the hose and store.
4. Reinstall the cap on the recreation vehicle inlet.

Fresh Water Tank With Gravity Fill

When an outside source of water is unavailable, water can be drawn from the fresh water storage tank for use in the recreation vehicle. The tank is filled through a gravity controlled water fill spout on the side of the recreation vehicle.

To fill the fresh water tank, proceed as follows:

1. Remove the water fill spout cap.
2. Water can now be added directly to the tank through the fill spout by use of a known clean hose or bucket, used only for this purpose.
3. When the tank is filled, replace the water fill spout cap.

NOTE: *Never leave the hose unattended while you are filling the fresh water tank.*

NOTE: *There is an overflow vent located at the top of the fresh water tank. If the tank is filled beyond capacity water will flow out through this vent onto the ground.*

NOTE: *Always fill the tank with clean potable water from a known safe source. Make sure to close the fill spout when the tank is filled. Also, always fill the system with a hose that you know is clean, and is used only for this purpose.*

When traveling, you may want to drain the tank, or keep the quantity of water in it to a minimum. This reduces the total weight of the recreation vehicle for travel. Make sure when draining the tank, that the water pump has been turned off. The fresh water tank drain valve is located below and near the fresh water fill spout. Water in the tank can be drained by turning the drain cock perpendicular to the recreation vehicle body. To close the valve, turn the lever parallel to the recreation vehicle body.

NOTE: *When trying to drain entire on-board fresh water system, make sure to open faucets, water heater drain, and system low point drains to remove all fresh water from the system.*

Fresh Water Tank Without Gravity Fill

When an outside source of water is unavailable, water can be drawn from the fresh water storage tank for use in the recreation vehicle.

To fill fresh water tank proceed as follows:

1. Attach a potable water hose to the inlet inside the rally kit area, and an outside water supply.
2. Turn the lever on the by-pass valve to the fresh tank position.
3. Begin filling the fresh water tank.
4. When the tank is full, turn off the water supply. View reading on monitor panel.

NOTE: *Never leave the hose unattended while you are filling the fresh water tank.*

NOTE: *There is an overflow vent located at the top of the fresh water tank. If the tank is filled beyond capacity water will flow out through this vent onto the ground.*

NOTE: *Always fill the tank with clean potable water from a known safe source. Make sure to close the fill spout when the tank is filled. Also, always fill the system with a hose that you know is clean, and is used only for this purpose.*

Water Pump

When using water from the fresh water tank, the system must be pressurized. A self-priming 12V DC pump is provided to handle this function. A pump ON/OFF switch is located on the monitor panel. The water pump is located next to the fresh water tank.

To access the water pump on Class A models, which have the water tank located between the rear wall and an above/below floor rear storage compartment, it will be necessary to remove the round access plate inside the rear compartment box on the driver's side of the recreation vehicle. Insert a large flat tipped screw driver in the recessed area of the round cover and with a twisting motion the cover should snap open.

When initially starting up the self contained water system, follow this procedure:

1. Make sure the tank is filled with water.
2. Open all the faucets in the recreation vehicle, both hot and cold.
3. Place the pump control switch in the ON position.
4. Allow time for the hot water tank to fill. Shut off each faucet as the flow becomes steady and free of air. When the last faucet is shut off, the pump should also shut off.
5. The system is now ready for use.

NOTE: *When filling the system, you may want to add additional water to the tank to replace the water used when filling the hot water tank and water lines.*

The self contained water system is a demand system. This means that the water pump will run whenever there is a need for water. If the pump runs while all faucets are closed, there may be a leak in the system. Ask your dealer for assistance.

NOTE: *The low point drains are located in the water lines on the floor of the recreation vehicle except the Windsport and Magellen brand recreation vehicles. Specific locations along the water lines will vary depending on the model of your recreation vehicle. The low point drains for the Magellen and Windsport models is the outside shower which is located in an exterior compartment, below the floor.*

Sanitizing the Fresh Water System

Sanitize the system before initial use, after extended periods of nonuse, at least once a year during continuous use, and whenever there is suspicion that the system has been contaminated.

To sanitize the system with a gravity fill, use the following procedure:

1. Prepare a chlorine solution using a gallon of water and $\frac{1}{4}$ cup of liquid household bleach (5% sodium hypochlorinate solution). Use one gallon of solution for each 15 gallons of tank capacity.
2. With tank empty, and all faucets and drains closed, pour the solution into fresh water tank.
3. Complete filling the tank with fresh water.
4. Switch on the water pump. Open all faucets one at a time until all air is purged, and the water flows freely.
5. Again add fresh water to the tank until the water level reaches the fill spout.
6. Allow the system to stand undisturbed for a few hours (at least three).
7. Drain the system by opening all faucets, and the fresh water tank drain valve, while flushing the system with water of drinking quality.
8. Continue flushing the system, allowing the water to flow for several minutes.
9. Close the tank drain valve and faucets. Refill the system with water of known drinking quality.

NOTE: *A slight chlorine taste may linger. If this is objectionable, mix a solution of 1 quart Vinegar to 5 gallons of water and add to the tank. Let stand for 3 hours and flush.*

To sanitize the system without a gravity fill, use the following procedure:

Items needed:

- 1 - Battery powered drill (do not use an electric drill)
- 1 - Drill powered water pump
- 1 - 5 gallon bucket to prepare solution
- 2 - 4 foot sections of $\frac{1}{2}$ inch inside diameter hose
- 2 - Female hose ends for $\frac{1}{2}$ inch hose with $\frac{3}{4}$ inch threaded end (compression style)
- 1 - Male hose end for $\frac{1}{2}$ inch hose with $\frac{3}{4}$ inch threaded end (compression style)
- 1 - 1 cup of household bleach

1. Install one male and one female hose end to one of the 4 foot sections of hose. When completed, the section of hose will have a male hose end on one side and a female hose end on the other side.
2. Connect this hose to the outlet side (usually marked with an arrow) of the pump. The other end of the hose will get connected to the city water fill on the coach. Prior to attaching the hose to the city water fill, remove the pressure regulator first, otherwise the pump will not be able to push the water past the regulator. The hose will attach to where the regulator use to be.
3. Install one female hose end to the other 4 foot section of hose.

4. Connect this hose to the inlet side of the pump. The end of the hose that does not have hose end will go into the five gallon bucket to pump out the sanitizing solution.
5. Fill the bucket half full with water and add one cup of household bleach. Attach battery drill to the pump making sure that the drill rotation matches the rotation needed to work the pump.
6. Using the drill, pump the solution from the bucket into the fresh water tank until solution is gone. Remove the pump/drill apparatus and complete filling the tank with water.
7. Switch on the water pump. Open all faucets one at a time until all air is purged, and the water flows freely. Once the tank is half empty turn off the water pump.
8. Again, add water to the tank until it is full. Allow the system to stand undisturbed for at least 15 minutes.
9. Turn the water pump on to drain the system by opening all faucets, and the fresh water tank drain valve, while flushing the system with potable water.
10. Continue flushing the system, allowing the water to flow for several minutes, and then turn off the water pump. Close the tank valve and faucets. Refill the system with potable water.

NOTE: *If you would rather not do the above, having your dealer perform this operation would be another option you could choose.*

MONITOR PANEL

The monitor panel allows you to quickly check the levels in the fresh water and waste water tanks. Electrical sensors at various points on the tanks send signals to the monitor panel. To check fluid levels, press and hold the test switch designated for the tanks, and read the level indicators on the panel. The indicator is proportioned in quarters with each light being lit up to the level that the tank contains.

Sometimes, residue on the sides of a tank, or water with a low mineral content will give a false reading. Check the levels occasionally when you are sure of a tank's contents to double check the accuracy of the monitor panel.

NOTE: *Other monitor panel functions such as checking the battery charge level are discussed elsewhere in this manual (see Index).*

Troubleshooting

When troubleshooting a problem with a Ventline conventional monitor system, always remember that there are three basic system components to consider.

1. The monitor panel assembly, which includes the circuit board, lights, and switching.
2. The wiring harness, which includes the wires and connectors which connect the monitor panel to 12 volt DC power, ground, tank sensors, LP sensors and switching.
3. The holding tank sensors, level sensors, and fresh water tank sensors.

In many cases a malfunction of one of the above components will be reflected in another, which can result in misdiagnosis of the actual problem. Ventline recommends a consistent, methodical approach to troubleshooting in order to diagnose and correct the problem with the minimum investment in time and resources.

Prior to troubleshooting any monitor panel problem, verify the following:

1. You are in possession of the correct wiring diagram for the specific system requiring diagnostics.
2. The 12 Volt power source is present and originates from the battery or the filtered side of the power converter.
3. The chassis ground is present and has a good connection through the negative side of the battery.
4. The monitor panel assembly has been inspected and is free from damage. Check for broken wires, loose components and connectors.
5. The wiring harness is connected properly and is free from damage.
6. The tank sensor and level sensor wires are connected properly and are free from damage.
7. The tank level sensors are properly located and are free from damage.
8. All wiring is done in accordance with the wiring diagram.
9. All of the above components are accessible during troubleshooting.

After the above is verified, proceed with troubleshooting the system. Refer to the monitor panel troubleshooting guide supplied separately from this owners manual.

Inaccurate Holding Tank Level Readings

The accuracy of two wire holding tank monitoring systems can be adversely affected by dirty tanks, unusual mineral content in the water, or improper holding tank probe location. These conditions can cause the monitoring system to have oversensitive (reads higher than actual level) or under sensitive (reads lower than actual level) readings.

Oversensitive Readings

Oversensitive readings can occur as a result of scum buildup on the tank walls, abnormally high mineral content in the water, or incorrectly located holding tank probes. In these situations, the monitoring system indicates higher levels than are actually present in the holding tank. Certain cleaning products and food byproducts can build up on the inside walls of the holding tanks, producing a layer of scum that can cause the monitoring system to read higher than the actual level. To correct this problem, the holding tanks should be cleaned periodically (consult dealer for cleaning instructions). If the problem persists after cleaning the holding tank, the ground probe can be moved farther away from the other tank probes. The increased distance between the ground probe and the other probes will decrease the sensitivity of the monitoring systems.

Under Sensitive Readings

Under sensitive readings can occur if the mineral content of the water is abnormally low or if the holding tank probes are located incorrectly. In this case, the monitoring system indicates lower levels than are actually present in the holding tank. This problem can be corrected by moving the ground probe closer to the other probes. Moving the ground probe closer increases the sensitivity of the monitoring system.

Technical Support

If the above information is inadequate to solve your specific troubleshooting requirement on any Ventline Conventional monitor panel system, please contact Ventline for technical support. Ventline technical support staff will require the specific model number of the monitor panel in question (marked on the rear of the monitor panel), as well as the make and model of the recreation vehicle in which the monitor is installed. Please be prepared with this information in advance. Failure to furnish this information will result in unavoidable delays and may prevent us from assisting altogether.

Ventline, Division of Philips Products
PO Box 629
902 South Division
Bristol, IN 46507
Phone: 574-848-4491 Fax:574-848-4825

WASTE WATER SYSTEM

The waste water system in the recreation vehicle can be described as two separate systems. A gray water system that consists of the drain lines and holding tank for waste water from the sinks and tub, and a black water system which includes the holding tank and drain for toilet wastes. In some cases the bathroom lavatory may drain into the black tank. Each system is self-contained, and allows disposal of waste water at designated dump stations at your convenience.

Components of the gray water system have drain traps, and both tanks are vented to equalize air pressure and disperse odors caused by drain water and wastes outside. Sometimes, the rocking movement of the recreation vehicle while driving may empty the drain traps of their water, and allow the odors of the gray water tank to come into the coach. Residue in the drain water lines can also produce odors. To combat gray water holding tank odors, an approved deodorizing agent should be used. An agent that dissolves grease and fats and contains a detergent will help keep tank and drain lines clean and free-flowing.

Holding Tanks

⚠ WARNING

Most chemical mixtures for holding tank odor control are poisonous. Follow the product manufacturer's directions and warning when using any holding tank additive.

Both holding tanks are approximately located beneath the bathroom area. Drain valves and drain hose storage are located on the driver's side. Each tank has a separate drain line and dump valve, which permits dumping tanks individually or together. Each tank should be emptied at a dump station designated for this purpose. Most national, state, and private campgrounds have dumping facilities. Many have hookups on the campsite, while some have portable dump collectors. Many service stations, particularly along interstate highways, also have these facilities. Many campground directories list dumping station locations across the nation.

If possible, dump holding tanks before a trip, to reduce the gross vehicle weight. Enough water should be kept in the black water tank to cover the bottom, to prevent hardening of any residue that may remain.

Do not dump black water tank until it is 3/4 full. This practice makes sure that enough water is in tank to flush all wastes into sewer lines. If necessary, fill tank to the 3/4 mark with additional water before draining.

Never put anything in the holding tanks other than normal drain water, wastes, and biodegradable products. Paper wrappers, gum, cigarettes, etc., no matter how small they may be, should never be placed into either the gray or black tanks.

NOTE: *It is important to note that harmful and toxic materials can accumulate if the holding tanks are not regularly drained and thoroughly rinsed. It is also important to use holding tank deodorizing and cleaning agents in the waste water tanks to reduce odors and keep the lines open and free-flowing.*

NOTE: *The diagram below shows a typical waste water system termination valve layout.*

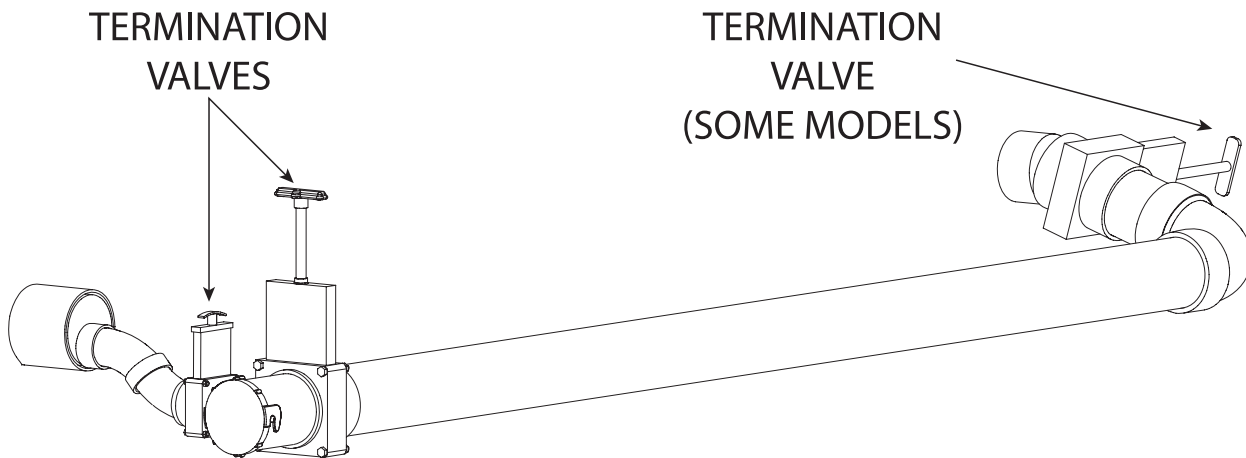

Emptying the Holding Tanks

1. Remove the sewer drain hose from its storage compartment on the side of the coach.
2. Remove the cap from the sewage drain, and connect the drain hose to it.
3. Attach the other end of the flexible drain line to the dump station inlet. Make sure both ends of the flexible drain line are securely attached.
4. Drain the black water tank first, by pulling the termination valve handle toward you. Make sure to allow sufficient time for the tank to completely drain, then rinse the tank with several gallons of water by depressing the stool pedal. Close the valve on the stool and let it fill before releasing the tank. This creates additional force to flush the tank more completely.
5. Drain the gray water tank by pulling the termination valve handle toward you. Draining the gray water tank last, with its soapy water helps to further rinse the drain and flexible hose,
6. When tanks are emptied, close termination valves by pushing handles back to closed positions.
7. Remove flexible drain hose and wash it thoroughly with clean water. Remove the other end from the dump station inlet, and replace it in its storage compartment. Secure the sewer hose storage cover, and replace the caps on both the recreation vehicle outlet and dump station inlet.

The following guidelines will help to ensure trouble free operation:

- Never put anything in black water tank other than toilet paper especially for recreation vehicle systems.
- Do not put automotive antifreeze, household toilet cleaners or drain cleaners, or any solid material into the waste water system.
- Always use chemicals in the black water system that are made especially for this purpose.
- When cleaning components of waste water system, use cleaners made for recreation vehicle systems.
- Always keep the drain cap in place, and termination valves closed.
- After every third time the holding tanks are emptied, fill and flush both tanks with clean fresh water a couple of times to keep them clear and clean.

NOTE: *If connecting to a campsite sewer inlet, DO NOT open termination valves until tanks are 3/4 full. DO NOT keep black water valve open while parked. Wastes are NOT flushed directly into sewer system. Only liquid waste is drained, therefore, water must accumulate, and chemicals in tank need time to break down solids before they can be released. If draining gray water tank directly into sewer inlet while parked, make sure to close termination valve for a period of time before leaving, allowing some water to accumulate in tank to use for flushing drain line and flexible hose.*

NOTE: *Always remember to clean up the dumpsite before leaving. NEVER empty your holding tanks directly on the ground, a roadway, river or stream. DO NOT POLLUTE.*

Toilet

The toilet installed in the recreation vehicle is connected to the pressurized fresh water system. The two most common style of toilets use either a foot pedal or hand lever to flush and add water to the bowl.

Hand Lever Style:

To flush the hand lever style, pull the lever forward (clockwise) until rinse clears the bowl. Be sure to release the lever slowly. Movement of the flush lever opens the waste valve and allows the water to pass into the holding tank.

To add water to the bowl, pull the lever forward (clockwise) approximately half way. This will open the water valve and leave the flush lever closed.

ADD WATER

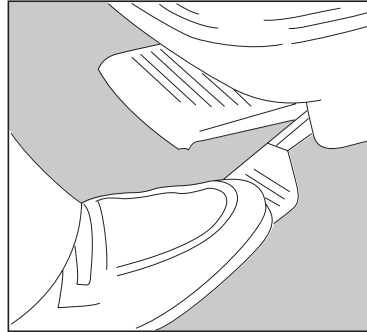

FLUSH

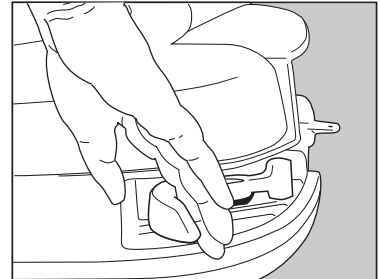
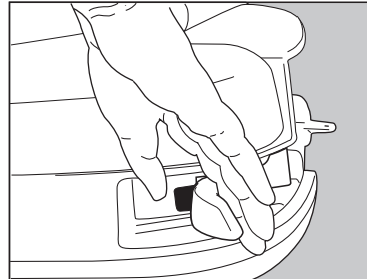
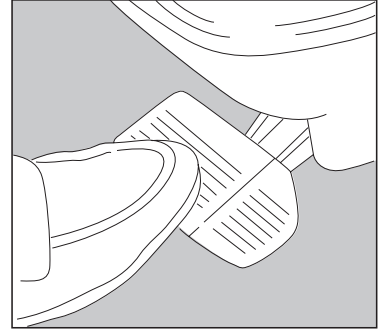

Foot Pedal Style:

To flush the foot pedal style, depress the large pedal on the left hand side until rinse clears the bowl. Be sure to release the lever slowly. Movement of the flush lever opens the waste valve and allows the water to pass into the holding tank.

To add water to the bowl, depress the small pedal on the right hand side. This will open the water valve and leave the flush lever closed.

NOTE: *Unnecessary frequent flushing of the stool will quickly deplete your fresh water supply and fill your holding tank. If the black water tank becomes full, you will no longer be able to flush the stool until the tank can be drained.*

REFERENCE: *Follow the toilet manufacturer's recommendations supplied with the toilet for cleaning and maintenance. If you have a toilet that differs from the description given here, make sure to follow the manufacturer's advice for operation.*

WATER SYSTEM WINTERIZATION

If you intend to store your recreation vehicle through periods of subfreezing weather in an unheated environment, it will be necessary to winterize the water system. Damage to water system components will result if proper winterization steps are not taken.

Class A, Kodiak & 750 Fun Mover Water System Winterization

1. Level the unit for good system drainage.
2. Drain the waste water tanks (black then grey following drainage guidelines).
3. Turn the water pump switch off.
4. Open all faucets, and water heater drain.
5. Open low point drains on the water lines, including the outside shower.
6. Drain the fresh water tank.
7. When all lines are drained, close water tank valve, all faucets, water heater drain, and low point drains on water lines.
8. Turn water heater bypass valve on to prevent tank from filling with antifreeze.
9. Remove water filter (if installed) and replace with bypass cap to protect filter.
10. If unit is equipped with an ice maker, turn off the water valve.
11. Position antifreeze so siphon hose can be connected to the winterizing connection.
12. Turn valve to position which will allow the water pump to pump from antifreeze container.
13. Turn on the water pump and let each faucet run until antifreeze flows freely from both hot and cold lines. Also run the shower and toilet until antifreeze is visible.
14. If unit is equipped with a washer/dryer turn on and let run until antifreeze is visible and continue to run for 15-20 seconds. Turn cycle selector to rinse cycle to ensure the antifreeze gets into the pump to protect it.
15. Turn off water pump.
16. Pour one cup of antifreeze in every drain to protect the P-traps.

Class C Water System Winterization

1. Level the unit for good system drainage.
2. Drain the waste water tanks (black then grey following drainage guidelines).
3. Turn the water pump switch off.
4. Open all faucets, and water heater drain.
5. Open low point drains on the water lines (pull up and twist valve) and the outside shower to let water drain.
6. Drain the fresh water tank using outside spigot type drains.
7. When all lines are drained, close water tank valve, all faucets, water heater drain, and low point drains on water lines.
8. Turn water heater bypass valve on to prevent tank from filling with antifreeze.
9. Remove water filter (if installed) and replace with bypass cap to protect filter.
10. If unit is equipped with an ice maker, turn off the water valve.
11. Remove water pump line at fresh water tank location and attach siphon hose to fitting.
12. Turn on water pump and let each faucet run until antifreeze flows freely from both hot and cold lines. Also run the shower and toilet until antifreeze is visible.
13. Turn off water pump.
14. Pour one cup of antifreeze in every drain to protect the P-traps.

Before using the system again in warmer weather, completely flush the system with water, flush the toilet, and sanitize the entire fresh water system. When using the recreation vehicle during cold weather and water in a tank or drain line should happen to freeze, you should take immediate steps to thaw it before damage to the system occurs. DO NOT continue to use water system components if such a condition exists. If damage has occurred, make sure to have it repaired before using again.

WATER SYSTEM MAINTENANCE & TROUBLESHOOTING

As with any mechanical system, your plumbing is subject to the development of problems. Most of these problems can be greatly reduced if not altogether eliminated by following a schedule of planned inspections and maintenance. Neglect of proper maintenance procedures is the usual cause of most water system problems.

Road vibrations and shocks, as well as excessive pressure from some city water sources are the main physical causes of water system damage. It is important to inspect all plumbing joints and fittings often for cracks and leaks. Water leaking from a plumbing joint can cause considerable damage if left unchecked.

A leak somewhere in the fresh water system should be suspected whenever the pump is running and all faucets and valves are closed. When the leaking fitting has been identified, attempt to stop the leak by tightening. DO NOT over tighten. Plastic fittings rarely need to be tightened with a wrench. If these fittings leak after tightening by hand, disconnect the fitting and check for dirt, scale,

or other foreign substances which may be causing the leak. Clean the fitting thoroughly and reinstall. If leaking persists, shut off the water supply until the fitting can be properly replaced. Check with your dealer for correct method of replacement, and replacement parts.

Proper winterization procedures of plumbing systems will normally be all that is necessary to prevent the damage caused by freezing. Freezing damage can harm any component of the system, including the water tanks, toilet, pump, and all piping. Be sure to follow the winterization procedures outlined in this manual. Also be sure to discuss any additional precautions that should be taken to winterize your motorhome's plumbing system with your dealer. Local climates vary; and winter maintenance needs may be effected.

Be sure to read the literature supplied with plumbing components, such as the pump, for troubleshooting tips. Also remember that it is possible for an electrical problem to cause water system problems. Lack of power to the pump can be caused by a variety of reasons. If you are unsure of how to locate and/or repair a plumbing problem, it is best to have your dealer or a qualified plumber handle the job.

PROPANE GAS SYSTEMS

DANGER

Propane gas is highly volatile and extremely explosive. Do not use matches or a flame to test for leaks. Use only approved Propane gas leak testing solutions for leak detection. Unapproved solutions can damage copper tubing and brass fittings. Never attempt to adjust propane gas regulators. Only qualified personnel should perform any maintenance or repair to the propane gas system.

The propane gas system furnishes the fuel for cooking, heating, and hot water. Propane gas can also be used as an alternate energy source for refrigeration. Propane is a clean, efficient, safe form of energy when proper handling and safety precautions are observed.

The Propane Gas system is designed to accept either Propane or Butane. However, since Butane vaporizes at about 32°F, it can only be used in areas where you can be sure of higher temperatures. Propane vaporizes at approximately -40°F. There are blends of Propane and Butane available, which will vary in the temperature at which it vaporizes. When filling the tank, select a Propane Gas that has a boiling point about 40° lower than temperatures you expect to travel in. Consult with your dealer, or local Propane Gas supplier about what you should be using.

PROPANE GAS TANK

The gas is stored under extreme pressure in the tank, with space in the tank to allow for expansion into vapor. This vapor is reduced in pressure by passing through a regulator. This reduction in pressure is a two step process which assures consistent pressure for use, regardless of outside temperatures, weather, or altitude.

NOTE: *For detailed information regarding propane gas and it's use, consult a qualified propane service representative.*

Filling the Tank

⚠ WARNING

Make sure that the tank is not filled beyond the 80% liquid level. Even though the tank is equipped with an automatic 80% shut-off which prevents over-filling beyond 80% tank capacity, it is a good idea to have the supplier monitor the 20% liquid gauge, and stop the filling process if liquid does appear. If the tank has been over-filled, make sure the Propane supplier bleeds out the excess. Over-filling the propane gas container does not allow for the necessary 20% vapor expansion space that can result in uncontrolled gas flow which can cause a fire or explosion.

NOTE: *Make sure the tank service valve is accessible at all times. In an emergency, it may be necessary to shut off the valve quickly.*

1. Before entering the propane bulk plant or service station, make sure all pilot lights are extinguished. Shut off gas to all appliances by first turning off each appliance, then close the propane gas main shut-off valve.
2. Extinguish open flames and smoking materials.
3. Never remove the propane gas tank from the recreation vehicle. Always drive the recreation vehicle to the gas supplier to fill.
4. Have the supplier connect the fill nozzle to the tank fill connection.
5. Always remember to close the supply valve, and open the 20% liquid level valve.
6. Never use a wrench to close the service or the 20% liquid level valve. If when closing by hand, leaking occurs, have the valve repaired or replaced.
7. Drive at least one mile from the propane gas supplier before relighting pilot lights or appliances. This will allow any minimal leakage which occurred while filling the tank to dissipate. DO NOT light pilot lights if you continue to smell propane gas. Shut off the Supply Valve. Allow the recreation vehicle to ventilate for 30 minutes. If you still detect propane odor, have the source of the leak located and repaired.

Never use any other tank than the one furnished with the recreation vehicle. If the tank must be replaced, check with your dealer for correct tank specifications and replacement procedure.

Propane Gas Regulator

WARNING

Never alter the positioning of the regulator. Propane gas regulators must always be installed with the diaphragm vent facing downward. Also make sure to keep the regulator cover in place to minimize vent blockage which could result in excessive gas pressure causing fire or explosion. Do not rely upon being able to smell propane gas leaks, as the odor may not be sufficiently strong enough to detect.

The regulator reduces the pressure of the propane gas vapor from the pressure in the tank, to the pressure required for use at the appliances. This reduction in pressure is performed by a two-stage regulator. Two regulators are used in the same body to reduce the pressure of the propane gas in the tank for use by the appliances in the recreation vehicle. The regulator seldom requires service, but it should always be protected from the elements and extremes of hot and cold.

The high pressure regulator (first stage) is used to reduce the pressure to approximately 10 to 13 PSI before sending it along to the low pressure regulator (second stage). This second stage regulator reduces the pressure further to 11 inches water column, or 6.35 ounces per square inch. The two stages regulator does not have to work as hard since the second stage receives consistent pressure rather than inlet pressure which varies. The result is an efficient safer system that helps to eliminate problems such as freeze up and pilot outage.

The regulator has been preset by the manufacturer of the regulator, and adjustment should not be necessary. If adjustment should be required however, DO NOT attempt to adjust it yourself. Adjustment must be made with special equipment by a qualified propane gas service technician. Have the regulator checked annually, or whenever you suspect a problem. The correct line pressure should be 6 ¼ oz. or 11 inches of water column.

Because air is required for proper operation of the regulator, it is very important that the regulator vent is kept clean and free of dirt and debris. This is why it is necessary to keep the vent facing downward and the regulator covered to protect it from contamination. A toothbrush can be used to clean the vent if it becomes clogged by foreign matter.

Regulator Freeze-Up

During cold weather, it is important to keep ice from forming in the regulator, which will shut off the flow of propane gas to the appliances. Have the supplier add a hydrous Methanol when filling the tank for use during cold weather. Regulator freeze-up can occur in any weather if there is moisture in the tank, or if the tank has been over-filled. Always use moisture-free propane gas, and make sure the tank has not been filled beyond 80% of capacity. If moisture has entered the tank, have the tank purged, or have hydrous methanol added by an authorized propane gas supplier.

If you believe a regulator has been damaged or otherwise is not functioning, have it replaced by a qualified propane gas service representative.

The term regulator freeze-up is a misleading one. Regulators and propane gas do not freeze. However, the moisture that can be contained in the gas will freeze as the gas expands and cools passing through the regulator. This freezing of the moisture in the gas can build up and partially or totally block the passage of the gas through the regulator. Freezing can also occur when outside temperatures are low enough to contribute to the freezing of the moisture in the gas.

The source of the moisture is varied. It can occur at the refinery or gas bulk plant, in the rail cars used to transport the gas, or even within the recreation vehicle propane gas tank. Moisture in an propane gas tank can occur when a tank service valve is left open, allowing moist air to enter and become trapped.

A two-staged regulator helps to reduce the possibility of freeze-up because of its larger orifice size, and the fact that heat is transferred through the walls of two regulators instead of just one.

There are several steps that can be taken to inhibit or prevent this from happening:

1. Make sure that the propane gas tank is free of moisture before refilling.
2. DO NOT overfill the propane gas tank.
3. Make sure to keep the service valve on an empty tank closed.
4. If freezing has occurred, have your propane gas dealer purge the propane gas tank before refilling.
5. Add a hydrous methanol or other approved propane gas antifreeze or de-icing agent to the propane gas tank.
6. Keep the regulator covered at all times.

NOTE: *If freeze-up does occur, shut off the propane gas at the tank. A frozen regulator may permit propane gas to flow at high pressure, resulting in leaks at appliances or in the lines. If freeze-up does occur, NEVER attempt to thaw with an open flame. Once thawed, be sure to take the proper steps to prevent a reoccurrence. Have the system checked by your propane gas supplier if freeze-up continues.*

Remember that as outside temperatures drop, the BTU value of the propane gas is lessened, since the colder liquid propane in the tanks requires the heat from the surrounding air to vaporize. This lowering of BTU value can significantly affect the performance of the system. You can help insure proper performance by keeping the propane gas tank as full as possible in cold weather, and reviewing the BTU/hr plates on propane gas appliances for proper propane management.

PROPANE GAS HOSES, PIPES TUBES & FITTINGS

The hoses, pipes, tubes, and fittings used in the propane gas system are designed to withstand pressures far exceeding those of the propane system. However, because environment and time can both contribute to the deterioration of these components, they must be inspected for wear at regular intervals. Be sure to inspect the hose before each season and when having the tank refilled. Look for signs of deterioration such as cracks or loss of flexibility. When replacing the hose or other propane components, make sure to always replace them with components of the same type and rating (check with your dealer).

PROPANE GAS DETECTOR

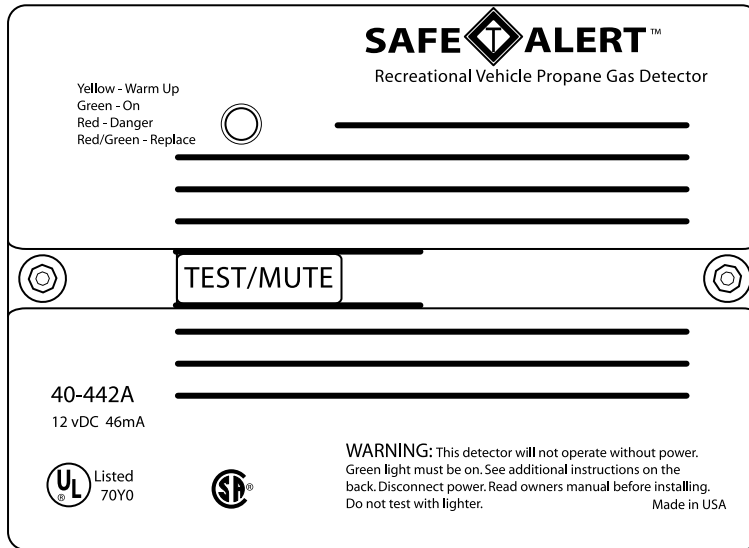

The Propane Gas Detector is powered at all times when the coach battery disconnect switch is in the ON position. When power is supplied to the detector the green indicator light will illuminate. After 60 seconds, the detector will begin monitoring the air in the recreation vehicle for combustible vapors. The propane gas you use to cook, refrigerate, and heat is combustible. Should a leak occur, the detector will produce a pulsating alert sound when the gas reaches the detector. This alert will continue to sound until the gas has dissipated or until the reset button is pressed. When the alert sounds, open all doors and major windows to air out the recreation vehicle and turn the gas off at the tank. Do not reenter the recreation vehicle until the alert stops sounding. If the alert sounds a second time after the gas is turned back on, leave the gas off and have a qualified propane gas dealer or RV service center make the necessary repairs. The reset button only stops the alert from sounding for 60 seconds. This device is intended for detection of propane gas ONLY.

Maintenance

NOTICE

Never use water, cleaners or solvents to clean the detector.

The following maintenance steps should be taken to ensure proper function of the detector.

- Test the detector at least once per week.
- Clean the detector at least once a month; gently vacuum the outside of the detector using the vacuums soft brush attachment.
- If detector becomes contaminated by excessive dirt, dust and/or grime, and cannot be cleaned to avoid unwanted alarms, replace the unit immediately.

REFERENCE: For proper battery maintenance and replacement procedures, refer to the manufacturer's owner's manual.

How to Test

WARNING

Never use an open flame of any kind to test this unit. The built-in test switch accurately tests the unit's operation as required by Underwriters Laboratories, Inc. (UL).

Simply press the TEST switch any time during the warm-up cycle or while in normal operation. The LED should flash red and the alarm should sound. Release the switch. This is the only way you should test your detector. The test feature checks the full operation of the detector. If this detector does not test properly return it immediately for repair or replacement.

TEST: *This test procedure should be repeated every week or every time the recreation vehicle is taken on a trip, whichever occurs first.*

REFERENCE: *Refer to the manufacturer's Owner's Manual or all the detector manufacturer, if you have any questions about the Propane Gas Detector.*

Checking the Propane Gas System for Leaks

WARNING

Never check for leaks with an open flame. The scent of propane gas (a garlic-like odor) is actually ethyl mercaptan, an additive that allows you to detect the presence of a leak, since propane gas is naturally odorless. Do not rely upon being able to detect the smell of the gas, as the odor may fade.

Road vibration can loosen propane gas fittings. It is important to check the propane gas system for leaks at least every 5,000 miles, and whenever the tank is filled. It is also a good idea to have the entire propane gas system checked annually by a qualified propane gas service representative.

Use the following steps when checking the system for leaks:

1. Open all the windows and vents.
2. Open the propane gas tank service valve.
3. Use non-ammoniate, non-chlorinated soap solution, or an approved leak detection solution on all line connections (ammoniate soap solutions can cause cracking on copper or brass lines and fittings).
4. If a leak is detected, tighten the connection with two open end wrenches until bubbling stops. DO NOT over tighten, or use excessive force. If the leak continues, contact the recreation vehicle dealer, or a qualified propane gas service representative to have an 11" Water Column Test performed.

About the Propane Gas Detector

Propane Gas is heavier than air and will settle to the lowest point which is generally the floor of the recreation vehicle. The detector is also sensitive to other fumes such as hair spray of which most contain butane as the propellant. Butane, like propane gas, is heavier than air and will settle to the floor level where it will be detected. When this occurs, press the reset button to stop the alert sound for 60 seconds.

Other combustibles which will be detected include alcohol, liquor, deodorants, colognes, perfumes, wine, adhesives, lacquer, kerosene, gasoline, glues, most of all cleaning agents and the propellant's of aerosol cans. Most are lighter than air in their vapor state and will only be detected when the coach is closed up. Glues and adhesives may exhaust hydrocarbon vapors for months after they are applied. They are easily activated by high temperatures.

The Propane Gas Detector is powered by the recreation vehicle coach batteries and/or the inverter. The detector will operate properly until the battery is drained down to 10 volts (a low battery condition is 10.4 volts). If the power source (battery and/or inverter) is disconnected, or if the power is otherwise interrupted, the detector will not operate.

The Propane Gas Detector has a self check circuit which runs at all times when the detector is powered. In the event that the circuitry fails, a failure alarm will sound. It is a continuous series of short beep tones between long intervals and is distinctively different from the alert sound.

Most Common Causes of Apparent Malfunction

New Coach Odor:

The glues and other materials used in manufacturing the recreation vehicle produce vapors which may be detected when the coach is closed up on a warm day. Air out the recreation vehicle thoroughly.

Continuous Beeping: The gas detector beeps about once every minute, even when it is turned off. The problem is a weak battery in the smoke detector which causes the smoke detector to produce short beeps which sound similar to the alert sound of the Propane Gas Detector. This is a high pitch tone and bounces off the walls, making its location very hard to pinpoint. If the sound is not coming from the Propane Gas Detector identify the source and refer to the sources section in this manual for means of repair.

Aerosol Activates the Detector: Most aerosol hair sprays use butane gas as the propellant. Butane, like propane gas, is heavier than air and will settle to the floor level where it will be detected. The detector is doing its job as butane is combustible.

Other Gases: Other gases which can cause the detector to respond with an alert include the vapors from any fuel, liquor, alcohol, deodorants, colognes, perfumes, wine, adhesives, lacquer, and most cleaning agents.

Slow Beep Rate: This could be the failure alarm and will occur in the event that the circuitry fails. It is a continuous series of short beep tones between long intervals and is distinctively different from the alert sound.

NOTE: After reviewing the above, if the problem still exists, contact MTI Industries for assistance.

NOTE: The Propane Gas Detector enters a cleaning and initializing mode every time it is powered. If turned OFF for less than 15 minutes, the Propane Gas Detector may produce several short “chirps” within the first 80 seconds of operation. This is a normal function of the Propane Gas Detector.

See your Four Winds International Dealer or a qualified propane gas service center should service be required. If they are not familiar with this product, have them call the detector manufacturer for assistance. If service is not available in your area, call MTI Industries.

PROPANE GAS SAFETY PRECAUTIONS

WARNING

DO NOT store propane gas containers inside the recreation vehicle. Propane Gas containers are equipped with safety devices which relieve excessive pressure by discharging gas to the atmosphere. Failure to comply could result in explosion resulting in death or serious injury.

If you smell propane gas:

1. Extinguish any open flames, pilot lights and all smoking materials.
2. DO NOT touch any electrical switches.
3. Shut off the gas supply at the tank valve(s) or gas supply connection.
4. Open all doors and other ventilating openings. (DO NOT USE THE RANGE HOOD).
5. Leave the area until the odor clears.
6. Have the system checked by a trained professional before using again.

Be careful when doing any work or maintenance in the recreation vehicle, that you do not puncture a gas line with a nail, screw, or drill bit.

Warning labels and decal's are used throughout the recreation vehicle in locations where the potential for a dangerous situation is present. They have been installed not only because of the requirement to do so, but also as a constant reminder to occupants of the recreation vehicle to exercise proper caution when using or being around propane gas appliances and equipment. Make sure that you and your family understand and follow all of them. Never remove these warning labels and decal's. If one should be lost, it should be replaced as soon as possible.

CARE & MAINTENANCE

Periodic maintenance and cleaning of your recreation vehicle is necessary to retain the dependability, safety, and appearance that will provide you with many miles of trouble free operation, as well as protecting your investment.

Make sure to read and follow all the maintenance tips and schedules that appear not only in this manual, but also in the manuals provided by the chassis manufacturer and various component manufacturers. Keep good records of maintenance functions performed, and make sure to perform all owner obligations as may be required by the chassis manufacturer to keep your warranty in force.

It is also important to note that operating conditions will effect service timetables. Driving in extreme conditions such as heavy dust, continuous short trips, or start and stop heavy traffic means that service durations will be shortened. Discuss service timetables with both your dealer and chassis service representative. Preventative maintenance will pay for itself many times over by catching or preventing problems before they occur. Many repairs costs are greatly increased due to the fact a small problem can begin to effect other parts and systems of the recreation vehicle if left unattended.

If a situation arises involving a maintenance or cleaning activity for which you are not sure of the proper procedure, do not hesitate to contact your dealer, or chassis service representative for information.

FIBERGLASS SIDING

The care of fiberglass siding is essentially the same as any automotive finish. Wash your recreation vehicle at least once a month. Use warm water and a mild detergent to clean the finish. Take care to avoid spraying water directly into refrigerator and furnace vents when washing the recreation vehicle. Remove bird and tree sap droppings, insects, and tar as soon as possible to avoid staining of the finish.

It is important to note that any finish will deteriorate with time. Dulling and fading can be increased by exposure to extreme sunlight, air pollutants, and excessive moisture. Surface weathering of fiberglass does not change the strength of the fiberglass. Regular washing and waxing of exterior surfaces is the best insurance against surface deterioration such as fading, yellowing, or chalking. If surface deterioration has occurred, check with your dealer for the steps required to restore the finish. Buffing may be necessary in extreme cases. Small cracks appearing in the fiberglass can be repaired by using a fiberglass filler. Allow the filler to harden, sand, and then repaint with gelcoat (check with your dealer for further instructions and product information).

Wax fiberglass surfaces at least once a year with a standard liquid or paste wax. Make sure to follow the directions for use as outlined by the product manufacturer. Make sure to wash and wax your unit out of the hot sun when exterior surfaces are cool.

Storage of the recreation vehicle out of direct sun is also a primary way to help preserve fiberglass finishes.

Physical damage to fiberglass should be taken care of immediately to avoid moisture from entering through breaks and causing problems with interior walls and components. Cover breaks in the fiberglass with plastic, sealing the edges with tape until proper repairs can be made.

NOTE: *DO NOT use rubbing compound or any abrasive cleaner or cloth on the recreation vehicle. If using a tar and insect remover, make sure it is safe for use on painted surfaces and striping decals.*

EXTERIOR PAINT (OPTIONAL)

The exterior painted finish on the recreation vehicle is of the finest quality. Proper maintenance will assure a long lasting durable finish.

NOTE: *Do not wax or polish the exterior for the first 60 days.*

Pressure Washing

Extreme caution should be used when using a pressure washer to wash the recreation vehicle, as severe damage to the paint could result. The tip of the pressure washer should never be adjusted to a "pin point" type spray. A fan type spray which disburses the water over a larger area should be used. Also, if the pressure is adjustable, set it to the lowest setting. The spray tip should remain a minimum of 30" away from the surface of the recreation vehicle to ensure safe cleaning.

NOTE: *Do not use rubbing compound or other abrasive cleaners on the recreation vehicle exterior. If using a tar and/or insect remover, insure it is safe for painted surfaces and decals.*

Precautionary Measures

- Avoid parking under trees or near ocean salt spray.
- Ice or snow should not be scraped from the painted surface. Brush off.
- If the recreation vehicle sets more than 24 hours, remove any front protective covering (bra) while not being driven.
- Commercial washes should be avoided. Wash with cold water using a mild liquid soap. Dry wiping with a dry cloth is not recommended.
- When driving -Avoid gravel roads.
- Anti-freeze, gasoline, or window solvent spilled on painted surfaces should be rinsed off with water immediately.
- Rinse off bugs and bird droppings daily with water.

Any exterior finish will deteriorate with time. Dulling and fading can be increased by prolonged exposure to extreme sunlight, air pollutants, and excessive moisture. Surface weathering of fiberglass will not diminish structural integrity. Regular monthly washing and polishing of exterior surfaces is the best insurance against surface deterioration such as fading, yellowing, or chalking. Take care to avoid spraying water directly into refrigerator and furnace vents when washing the recreation vehicle.

If surface deterioration is apparent, contact a Four Winds International dealer for assistance with finish restoration. Physical damage to the fiberglass, such as cracks, holes, and chips, must be attended to immediately to avoid moisture from entering and causing problems with interior walls and components. Cover these areas with plastic, sealing the edges with tape until proper repairs can be made.

SEALS AND ADHESIVES

Failure to maintain seals through regular maintenance can lead to damage of recreation vehicle components, and may be considered abusive treatment under terms of your recreation vehicle warranty.

It is important to maintain the seals and adhesives of your recreation vehicle to prevent moisture from entering and destroying recreation vehicle components. When washing your recreation vehicle, inspect the seals for signs of drying out and wear. Be aware that weather, sun, and road vibration will have an effect on seals, causing them to dry, crack, or separate. If you are unsure what to look for, have your dealer instruct you, and also show you the correct method for renewing the seals. All exterior seals should be checked and resealed as needed at least every six months.

NOTE: *It is especially important to check the seals before and after periods of extended storage or non-use. Fall and spring inspections are recommended.*

NOTE: *Be aware that moisture can accumulate in locks and hinges of windows and doors, causing damage or faulty operation. Do not force the operation of these components in sub-freezing weather.*

FRAME

Check the condition of the frame regularly. Keep it clean, and repaint as necessary to help avoid rust. It is especially important to keep under-body components clean, when driving the recreation vehicle in the winter in areas where road salts are used.

TIRES & RIMS

Using soap, water, and a medium bristle brush will keep the sidewall clean and the whitewall looking bright.

To keep the rims of the recreation vehicle looking their best, follow these simple steps:

1. Rinse the wheel with high-pressure water to remove any debris, grit or dirt particles.
2. Use a 100% cotton cloth dipped in a mild soap solution to help remove stuck on dirt and grease.
3. Rinse the remaining soap residue from the wheel.
4. Dry the wheel thoroughly with a 100% cotton cloth.

NOTE: *In areas where hot sun constantly beats down on the recreation vehicle, shading the tires by covering can reduce tire sidewall cracks from forming.*

ROOF

Inspection of roof components at least twice a year is very important to make sure seals are not cracked or worn. Proper maintenance of seals is necessary to keep moisture from entering and causing severe damage such as rot, mold, or mildew. If you encounter drying, cracked, or weathered seals, make sure to reseal as necessary. Check with your dealer for the type of caulking required for roofs and correct methods of resealing. Special sealers are also required for the skylights.

It is especially important to check the seals before and after periods of extended storage or nonuse. Fall and spring inspections are recommended. Four Winds International recommends all roof maintenance be performed by your dealer.

NOTE: *If your roof should somehow be punctured, cover the puncture to seal out moisture, and have it repaired as soon as possible (check with your dealer).*

EXTRUSIONS & ALUMINUM SURFACES

Clean and wax all extrusions when waxing recreation vehicle sidewalls, to help avoid surface pitting. Special aluminum cleaners are available to restore the original luster to aluminum surfaces. Make sure to follow the instructions for use as outlined on the product package.

Chrome surfaces can be restored with special chrome polish if regular cleaning methods are not successful. Again, make sure to follow product instructions for use.

WINDOWS & DOORS

Check the seals around the windows at regular intervals. Follow previous instructions for checking the condition of seals and repairing as necessary.

Make sure that windows remain operative by adjusting and lubricating latches and moving parts annually. Also check the condition and operation of the door locks, adjusting and lubricating as necessary. Use powdered graphite or light oil to lubricate moving parts on doors and windows.

Vinyl seals around windows and doors should be cleaned regularly, and kept supple by use of a silicone spray (make sure to follow the directions on the product).

Keep screens and window slides clean and free of debris, to maintain proper operation, and avoid component road damage. Test the operation of all windows occasionally to make sure they are working properly, including closing flush and locks holding tight.

Check with your dealer if you are unsure about the correct methods of lubrication and adjustment.

NOTE: *Be aware that moisture can accumulate in locks and hinges of windows and doors, causing damage or faulty operation. Do not force the operation of these components in sub-freezing weather.*

PROPANE GAS SYSTEM

The Propane Gas system should be checked regularly for leaks and damage. Follow the lines, looking for kinks or flattened spots that could have occurred during travel or maintenance on the recreation vehicle. The entire system, including regulator pressure, should be checked annually, or whenever you suspect a problem, by a qualified Propane Gas service technician using proper equipment. The method of checking the system for leaks, and Propane Gas safety precautions can be found elsewhere in this manual.

NOTE: *Line pressure for Propane Gas appliances should be checked at least every six months. Most Propane Gas suppliers have equipment to make the test for you. The correct line pressure for all of the Propane Gas appliances is 11" of water column pressure.*

DRAINAGE SYSTEM

The drainage system, including the tanks and associated drain piping should be periodically inspected for road damage. Any deterioration of the sealant around joints and fittings should be repaired immediately.

Check the operation of the termination valves. If they pull or close with effort, lubricate the shaft and slide valve with spray silicone. Termination valves that leak should be repaired or replaced as soon as possible.

Sometimes, a buildup of paper or other material in the inside groove of the termination valve can obstruct the valve and cause it to seat improperly. If you suspect that this is occurring, the valve can be removed from the drainage line by removing the four screws that hold it in place and sliding it out. The valve groove may then be cleaned out with a screwdriver or similar tool. Replace the valve in the line and reinstall the screws to secure it in place.

TV ANTENNA

To lubricate the elevating gear, apply a liberal amount of silicone spray lubricant to the elevating gear with the lift in the down position. Run the lift up and down a few times to distribute the lubricant over the gears.

If rotating the antenna becomes difficult, normal operation can be restored by lubricating the bearing surface between the rotating gear housing and the base plate. Any spray type silicone lubricant may be used.

Elevate the antenna and remove the set screw from the rotating gear housing (see illustration). Spray lubricant into hole and around the edges of the gear housing. Rotate the gear housing until the lubricant coats the bearing surfaces and the antenna rotates freely.

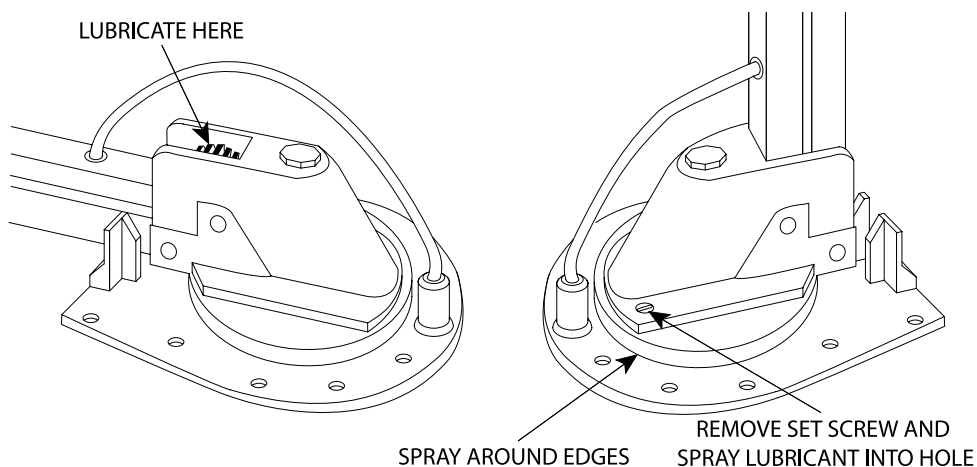

EXTERIOR LIGHTS

Make sure to check the operation of all exterior lights often. Check identification, clearance, turn signal, brake, and backup lights to make sure they are working correctly. Replace burnt out bulbs as soon as possible.

Headlamp Condensation

Condensation occurs when the air inside the lamp assembly, through atmospheric changes, reaches the “dew point”. When this takes place, the moisture in the air within the lamp assembly condenses, creating a fine mist or white fog on the inside surface of the lamp lens or chrome reflector surfaces. The headlamps are designed to remove accumulated moisture vapor by expelling it through a vent system as the light warms up. The vent system operates at all times, however it is most effective when the lamps are on and the vehicle is in motion. Since most recreation vehicles are parked for long periods of time, they have a greater chance of condensation build-up.

NOTE: *Check headlamp regularly for condensed water drops (daily in high humidity areas).*

If small drops of condensed water are noted, drive the recreation vehicle with headlamps “ON” or just turn “ON” the headlamps. This will evaporate the condensed water drops and will avoid water being accumulated. Depending on the size, shape and location of the lamp on the recreation vehicle, and the atmospheric conditions occurring, the amount of time required to clear the lamp may vary.

Check the headlamp vent tubes, this will be a small rubber hose or plastic cap located on the back of the light, make sure that they are free of dirt and the rubber is not cracked or dried out. If the vent tubes are clogged, cracked or dried out the vent system will not work correctly, allowing condensation to build up in the lamp. If the tube is cracked or dried out please replace it, replacement parts can be acquired from your RV Dealer.

Headlamp Maintenance

Cleaning is the most effective maintenance that you can perform on your lights, dirt and road grime build up can cut light output by 40% or more.

When cleaning your headlamps, please observe the following: do not rub them dry, and never use abrasives or strong solvents. Remove dirt and contamination, such as insects, by soaking with shampoo and then rinsing with plenty of water. Always use a de-icer spray to remove accumulated ice and snow; never use a scraper.

Headlamp seals should not be directly sprayed with high pressure (home or industrial) wash systems. Damage to the seal can occur, causing the housing to leak water.

Chemicals: Composite headlamps have a polycarbonate lens, which is very sensitive to a variety of chemicals. Contact with certain chemicals can cause crazing, softening or cracking of the lens, which would require replacement of the entire lamp housing. The following chemicals are suspected to cause similar results. Mild soap and water is recommended for the cleaning of your lamps.

Do NOT use the following to clean the headlamp lens:

Acetone	Gasoline	Oils
Agitene®	Kleenol Plastics	Pink Lux® (phosphate free)
Benzyl	Lemon Joy® (phosphate free)	Stanisol Naphtha®
Carbon Tetrachloride	Lestoil®	Texiz-8006, 8129, 8757
Chlorinated	Liquid Cleaner - 8211	Toluol
Citrus Orange Cleaners	Liquid Detergents	Tricholor
Corrosive or Caustic Cleaners	Lysol®	Triclene®
Diversol ®	Methyl Ethyl Keyton (MEK)	

NOTE: *Damage to the lamp assembly by these chemicals is not covered under the manufacturer's warranty.*

Headlamp Bulb Replacement**NOTICE**

To prevent injuries and damage, comply with any instructions provided by the bulb manufacturer.

Whenever working on any electrical system, switch off the electrical accessory you are working on or refer to the electrical system section of your owner's manual. Failure to do this could result in short circuits.

When replacing the halogen bulb do not touch the glass portion of the bulb with your bare hands since even small amounts of impurities burn into the surface and reduce the service life of the bulb. Use a clean cloth, paper napkin, or similar material to hold the bulb during installation. With most bulbs you will not need to touch the glass part to install the bulb.

SINKS & COUNTERTOPS

Clean with hot soapy water or a good liquid cleaner. Avoid using abrasive cleaners. Never use steel wool on stainless steel, since the steel particles left in the sink can rust and become unsightly. Also, when cleaning stainless steel with a mild cleanser, rub gently with the grain, and rinse well. Rinse after each use and wipe dry.

NOTE: *Do not place hot pans directly on countertops, because they can loosen or scorch surface.*

APPLIANCES

Make sure to read all literature provided with each of the appliances, and follow the maintenance instructions included. Pay particular attention to any cautions or warnings included. Each appliance in the recreation vehicle is warranted by their respective manufacturer.

Propane Gas Appliances & Equipment

Follow the instructions and warning noted in the appliance and equipment owner's manual as well as the ones listed below:

- Annual maintenance should be conducted on the the Propane Gas appliances and equipment by an authorized dealer or repair facility.
- Insects can build nests in the burners of the various appliances and equipment. The burner and burner orifice of the Propane Gas appliances and equipment should be cleaned out by an authorized dealer or repair facility anytime circumstances or conditions warrant, but no less frequently than on an annual basis.

PRE-FINISHED PANELS & WOOD SURFACES

Treat cabinetry and wood surfaces as you would any fine furniture product in your home. Proper care and maintenance of wood products will keep them looking like new for many seasons of use.

Clean pre-finished panels with a spray-type furniture polish. Avoid getting wood surfaces wet. Wipe off and dry immediately if this occurs. Do not use abrasive cleansers around wood finishes. Clean regularly with a soft cloth and cleaner designed for wood products such as lemon oil or any oil based wood cleaning product. Avoid constant exposure to direct sunlight which can cause fading and drying of wood surfaces.

WATER SYSTEM

Check all hoses, fittings, and connections regularly for leaks and signs of wear. Make sure to keep the system sanitized, and take care to winterize during cold weather (see instructions elsewhere in this manual). Do not allow water to remain in system for extended periods or after a trip.

ELECTRICAL SYSTEM

The electrical system requires minimal maintenance under normal circumstances. Most electrical maintenance in the recreation vehicle involves the chassis and auxiliary batteries. Keeping the batteries properly maintained will help to eliminate many frustrating electrical problems. Make sure to refer to the index for the location of electrical and battery maintenance elsewhere in this manual.

The generator is another area in which simple preventive maintenance can “head off” problems before they happen. Read the manual supplied with the generator for the care and maintenance required on a regular basis. If you experience electrical problems with your recreation vehicle, make sure to have it checked by a qualified electrician.

ROOF VENTS

Check roof vents regularly for debris that may block air flow or jam the cranking mechanism. Lubricate the cranking mechanism with light oil.

ABS PLASTIC

NOTICE

Avoid abrasive cleansers (even the liquid and cream types), alcohol based products, and solvents such as acetone and MEK. Gasoline and kerosene should not be used because of the damaging effect they have on the plastic surface, as well as the fire hazard they present. Often the damage caused by solvents, alcohol, citrus based and oil based products may not be immediately noticeable, but the plastic is made weaker, and prone to stress cracking.

Many components of the recreation vehicle are constructed of strong, lightweight ABS plastic. Sometimes, it may be necessary to remove stains, or generally clean. A mild solution of soap and water will clean many stains, and should be used initially. Tougher stains may require stronger cleaners, but be sure to read the label to determine if the product is recommended for use on plastics.

WINTER PRECAUTIONS

Water System

If the fresh water storage tank is located inside the coach, the normal heating of the coach during moderately cold weather should be enough to insure its not freezing. In severe cold however, it is wise to monitor the water temperature in the tank, and take appropriate steps to drain and winterize if necessary. In severe cold it may be necessary to open lower cabinet doors at night in both the bath and kitchen areas to keep warmer air circulating around water fixtures.

If you are going to have to leave the coach unheated for any length of time in severe cold conditions, it is best not to keep water in the fresh water tank. It may work best to carry cooking and drinking water with you in plastic jugs instead.

If you will be using your recreation vehicle when conditions fall below the freezing level, it will be necessary to protect the drainage system components from damage by the addition of an approved antifreeze solution as outlined on the product directions. Drain lines which are exposed outside the recreation vehicle are especially susceptible to freezing, and steps should be taken to protect them from damage.

Food Storage

In the event the recreation vehicle is left for a period of time without the furnace in operation, canned goods and other foods packed in water should be stored as high as possible, since heat rises. They might also be stored in the refrigerator as insulation against the cold. Store dry foods, and other items that are not damaged by freezing in the lower storage areas.

Propane Gas System

Make sure to use a Propane Gas that will vaporize properly in the colder temperatures. Check with your Propane Gas representative for the proper fuel, and read the information on Propane selection in the Propane Gas section of this manual (check the Index for the location).

NOTE: *It is important to remember that heating with Propane consumes gas rapidly, so refill tank immediately when low, to avoid running out completely.*

Heating

⚠ DANGER

Never use the range for heating. Asphyxiation could result.

Use ONLY the furnace to heat the recreation vehicle. It is properly vented to the outside.

Condensation

Cooking produces large amounts of moisture. Not just as steam from pots and pans, but also as a product of combustion. Make sure to use the exhaust vents and open a window slightly to control the humidity. At night, leave a roof vent and/or a window slightly open.

STORAGE PREPARATION

When storing the recreation vehicle for the winter (or other extreme conditions), certain precautions need to be made to protect it until you open it again for use. Make sure to talk with your local dealer concerning any special requirements for storage in your particular geographic area. The following steps are general, and your dealer can help you choose those that are most appropriate for your needs.

1. Make sure to park the recreation vehicle on a level surface.
2. Make sure to winterize the chassis as outlined in the chassis owner's manual, and also the 120V generator (if so equipped) as outlined in the generator owner's manual.
3. Clean the recreation vehicle thoroughly, both inside and out, as previously outlined including the refrigerator.
4. Make sure all electrical switches and appliances are turned off.
5. Close all the drapes and curtains, and protect the curtains from sun fading by placing foil, or paper between the windows and the screens.
6. Make sure all windows, doors, and vents are closed securely. Cover exterior vents on appliances to prevent moisture and insects from entering during storage.
7. Check the interior of the recreation vehicle periodically while in storage to make sure leaks have not developed, or condensation formed that can cause damage to interior components. Condensation can most readily be observed as moisture accumulation on windows and mirrors. To reduce condensation, make sure to air the recreation vehicle out occasionally during storage.
8. Be sure that both the chassis and auxiliary batteries have the proper electrolyte level and that they are fully charged (specific gravity of 1.260). A discharged battery will freeze and crack the case, ruining the battery. In storage, a battery will lose charge gradually over a 30 to 45 day period, even when disconnected by use of the battery disconnect switch. We recommend that at least monthly the batteries be checked for charge. If the charge is 80% (specific gravity of 1.235) or less, it must be recharged.
 - You may wish to remove the batteries from the recreation vehicle and store them in a heated area. However, even when warm, the battery charge level must still be maintained, a warm battery accepts charge much more readily however, than a cold one.
 - Make sure to follow all precautions associated with battery care and maintenance outlined in the electrical section of this manual.
9. Store with as much fuel as possible in the fuel tank to limit condensation buildup.
10. Check engine coolant, making sure antifreeze is sufficient for local temperature extremes.
11. Make sure the tires are inflated to correct pressures.
12. Store the windshield wiper arms and blades inside the recreation vehicle.
13. Let the engine run for a period of time until it is warm. Change the oil and oil filter.
14. Run the air conditioner during this final engine warm up to make sure the compressor seal is lubricated.
15. If snow accumulates on the recreation vehicle, try to remove it as often as you can.

16. A primary concern when winterizing the recreation vehicle is to make sure the water systems are protected against damage caused by freezing. Follow the water system winterizing procedure outlined in the Water and Drainage section of this manual (check the Index for location).

NOTE: *Be sure to read the rest of this manual, and follow any additional information on storage, cleaning, and winterizing procedures.*

MOLD

Molds are microscopic organisms that naturally occur in virtually every environment, indoors and out. Outdoors, mold growth is important in the decomposition of plants. Indoors, mold growth is unfavorable. Left unchecked, molds break down natural materials, such as wood products and fabric. Knowing the potential risks is important for an owner to protect their investment.

What Factors Contribute to Mold Growth?

For mold growth to occur, temperatures, indoor or outdoors, must be between 40 degrees and 100 degrees Fahrenheit and also have a source of moisture, such as humidity, standing water, damp materials, etc. Indoors, the most rapid growth occurs with warm and humid conditions.

How can Mold Growth be Inhibited?

By controlling relative humidity, the growth of mold and mildew can be inhibited. In warm climates, use of the air conditioner will reduce the relative humidity. Vents are located in the bathing and cooking areas and constant use is advised during food preparation and bathing, even during colder weather. Additionally, opening a window during these activities will assist in ventilation. In extremely humid conditions, the use of a dehumidifier can be helpful.

NOTE: *If using a dehumidifier, please read and follow all manufacturer instructions and recommendations to the use and cleaning of the dehumidifier.*

Ideally, relative humidity should be at 60% or less. Relative humidity can be monitored utilizing a portable hygrometer, a small device that measures temperature and relative humidity. Hygrometer's are available at electronics or building supply stores for minimal cost.

NOTE: *In cold climates, relative humidity may need to be at 35% or less to avoid window condensation.*

Frequent use of the recreation vehicle or cleaning regularly is an important preventive measure. Further, any spills should be wiped up quickly and dried as soon as possible. Avoid leaving damp items lying about. On safe surfaces, use mold or mildew killing cleaning products. Check sealants regularly, and reseal when necessary to avoid water leaks. Proper preventive maintenance to the recreation vehicle and its accessories, as described both in this manual and in accompanying literature, will provide the best protection to the recreation vehicle.

For more information of controlling moisture in the recreation vehicle, please read “*Tips to Controlling Condensation*”, located in this manual.

NOTE: *If you have any questions about moisture-related issues in the environment you plan to use the recreation vehicle in for a majority of the time, contact Four Winds International.*

Effects of Prolonged Occupancy

Your recreation vehicle was designed primarily for recreational use and short-term occupancy. If you expect to occupy the recreation vehicle for an extended period, be prepared to deal with condensation and the humid conditions that may be encountered. The relatively small volume and tight compact construction of modern recreation vehicles mean that the normal living activities of even a few occupants will lead to rapid moisture saturation of the air contained in the recreation vehicle and the appearance of visible moisture, especially in cold weather.

Just as moisture collects on the outside of a glass of cold water during humid weather, moisture can condense on the inside surfaces of the recreation vehicle during cold weather when relative humidity of the interior air is high. This condition is increased because the insulated walls of a recreation vehicle are much thinner than house walls. Estimates indicate that a family of four can vaporize up to three gallons of water daily through breathing, cooking, bathing, and washing. Unless the water vapor is carried outside by ventilation, or condensed by a dehumidifier, it will condense on the inside of the windows and walls as moisture, or in cold weather as frost or ice. It may also condense out of sight within the walls or the ceiling where it will manifest itself as warped or stained panels. Appearance of these conditions away indicate a serious condensation problem. When you recognize the signs of excessive moisture and condensation in the recreation vehicle, action should be taken to minimize their effects. For tips on controlling condensation see the “*Tips to Controlling Condensation*” section.

NOTE: *Your recreation vehicle is not designed, nor intended, for permanent housing. Use of this product for long term or permanent occupancy may lead to premature deterioration due to long-term occupancy may not be considered normal, and may under the terms of the warranty constitute misuse, abuse or neglect, and may therefore void certain warranty protections.*

Tips to Controlling Condensation

To avoid condensation problems, try to follow these tips to help alleviate excess moisture.

- Allow excess moisture to escape to the outside when bathing, washing dishes, hair drying, laundering, and using appliances and non-vented gas burners.
- Always use the vent hood when cooking.
- Keep the bathroom door closed and the vent or window open when bathing and for a period of time after you have finished.
- Do not hang wet clothes in the vehicle to dry.
- In hot weather, start the air conditioner early as it removes excess humidity from the air while lowering the temperature.
- Keep the temperature as reasonably cool during cold weather as possible. The warmer the vehicle, the more cold exterior temperatures and warm interior temperatures will collide on wall surfaces, thus creating condensation.

- Use a fan to keep air circulation inside the vehicle so condensation and mildew cannot form in dead air spaces. Allow air to circulate inside closets and cabinets (leave doors partially open). Please keep in mind that a closed cabinet full of stored goods prevents circulation and allow the exterior temperature to cause condensation.
- The natural tendency would be to close the vehicle tightly during cold weather. This will actually compound the problem. Simply put, you need to remove some of the warm air, and allow some cool outside air to get inside the vehicle, so the furnace will not recycle the humid interior air.
- Use fluorescent ceiling lights and minimize prolonged use of incandescent lights, which produce heat and contribute to condensation in the roof above the ceiling lights.

Avoid Drastic Thermostat Setbacks

Cooler surface temperatures increase the potential for condensation and surface mold growth. To minimize the opportunity for condensation to form on interior surfaces, maintain a comfortable temperature in the recreation vehicle, and avoid nighttime setbacks of 10° or more. Drastic setbacks that reduce the indoor air temperature quickly can increase the chance for airborne moisture to condense on cool surfaces such as windows. If you are away from the recreation vehicle for an extended number of days, we recommend that you do not set the temperature back without taking other measures to manage relative humidity, including operating a dehumidifier with a continuous drain.

Carpet Care & Moisture Management

The carpet should be cleaned when it shows signs of discoloration or traffic patterns. The use of a professional steam cleaning system is recommended for cleaning the carpet, unless otherwise noted. To manage moisture from the cleaning process, the cleaning system needs to be capable of extracting the excess water from the carpet after it has been cleaned. Important: Be sure the carpet is thoroughly dry before closing the recreation vehicle for storage. Water from the cleaning process can cause significant damage to the recreation vehicle if the carpet is not completely dry before closing up the recreation vehicle for an extended period.

Exterior Care of the Recreation Vehicle

The exterior shell of the recreation vehicle is the primary weather and moisture barrier. Over the life of the recreation vehicle, the shell will require regular care and maintenance. The shell includes the roof, sidewalls, windows, doors and under carriage of the recreation vehicle. Particular attention needs to be devoted to ensure these components are maintained to ensure a tight barrier against bulk water intrusion.

The shell should be inspected periodically for tears, gaps, and condition of sealants. Areas that require maintenance should be resealed utilizing a proven, high quality sealant of similar characteristics as the original sealant

Particular attention should be devoted to ensure the slideouts are functioning properly. Each time a slideout is used, it should be inspected to ensure proper operation and sealing. The slideout gaskets should also be inspected to ensure proper sealing when the slideout is operated.

Storage of the Recreation Vehicle

During those periods when the recreation vehicle is not in use, care must be taken to ensure moisture sources are addressed. Ideal storage of the recreation vehicle would be in an enclosed climate controlled environment. When this is not possible, the following steps should be taken to ensure moisture is controlled:

- Turn off all water sources.
- Turn off all combustion appliances.
- Drain the water tank(s).
- Drain the water heater.
- Open all closets, cabinet doors and drawers.
- Close all windows and entrance doors.
- Open a vent enough to allow for some limited ventilation air flow, but not so far as to allow snow or rain to enter.
- When storing the recreation vehicle high humidity climates (ambient relative humidity is greater than 60% year round), add a dehumidifier drained to the exterior to control humidity inside the recreation vehicle during storage.

Areas that are exposed to water spills or leaks should be dried as soon as possible and definitely within 24-48 hours. Drying areas quickly minimizes the chance for moisture damage and possible mold growth, which can begin to form colonies in 48 hours. A variety of methods can be used to help the drying process:

- Remove excess water with an extraction vacuum.
- Use a dehumidifier to air drying.
- Use portable fans to move air across the surface.
- Because moisture is key to mold issues, treat all signs of condensation and spills seriously and deal with promptly. Failure to deal with a moisture issue promptly may cause more severe issues where none initially existed, or may make a small problem much worse.
- Learn to recognize signs of mold - don't paint over or cover up suspicious discoloration until you are sure it is not mold. The affected surface must first be cleaned and dried; residual staining may be painted.
- Be sure to understand and eliminate the source of moisture accumulation as a part of the clean-up. Otherwise, the same issues will simply reoccur; and
- Small amounts of mold should be cleaned as soon as it appears. Small areas of mold should be cleaned using a detergent/soapy solution or an appropriate household cleaner. Gloves should be worn during cleaning. The cleaned area should then be thoroughly dried. Dispose of any sponges or rags used to clean mold.

PERIODIC MAINTENANCE CHART

For your convenience, a Maintenance Chart is presented below. For detailed information regarding specific product service and maintenance procedures, refer to the products respective owner's manual.

NOTE: The following chart is a guide only. Service and maintenance intervals may vary depending on product performance, usage, and/or environmental conditions.

ITEM							PROCEDURE
	EACH TRIP	MONTHLY	EVERY 3 MONTHS	EVERY 6 MONTHS	YEARLY	AS REQUIRED	
Fiberglass Exterior	▲						Wash with Warm Water & Mild Detergent
				▲			Wax with Liquid or Paste Wax
Roof & Roof Components			▲				Inspect & Reseal as Needed
					▲		Lubricate Roof Vent Mechanism with Light Oil & Clean
					▲		Lubricate Roof Antenna with Silicone Lubricant Spray
Windows & Doors	▲						Check Vinyl Seals when Washing Exterior
		▲					Check Seals for Damage & Repair as Needed
		▲					Lubricate Door Hinges & Step Components
					▲		Adjust & Lube Window Latches
					▲		Lubricate Door Locks & Strike Pocket, Include Exterior Storage Doors
Seals & Adhesives	▲						Inspect & Reseal as Needed
LP Gas System					▲		Check for Leaks & Road Damage
					▲		Qualified Service Technician Inspection
Water Drainage		▲					Check Hoses, Fittings & Connections for Leaks & Signs of Wear
	▲						Check Drainage System for Leaks & Road Damage
					▲		Sanitize Fresh Water System
					▲		Winterize System Depending on Local Seasonal Conditions
Electrical System		▲					Check GFCI Circuits
					▲		Generator Maintenance as Outlined in Generator Manual
		▲					Check & Service Batteries
Appliances	▲						Remove Food & Ice from Refrigerator
		▲					Clean Fan Blades & Wash Filter on Range Exhaust Hood
		▲					Check for Obstructions & Dirt on Exterior Appliance Vents
Safety Equipment					▲		Clean CO, Smoke & LP Detectors
	▲						Test All Detectors
		▲					Check Fire Extinguisher Pressure & Condition
Carpeting	▲						Vacuum
					▲		Clean
Wood Surfaces		▲					Clean Pre-Finished Panels & Wood
Seats					▲		Lubricate all Mechanisms & Inspect for Proper Operation
					▲		Check all Seat Belt Buckles, Release Mechanisms & Belt Webbing
Chassis Components					▲		Follow Chassis Lubrication & Maintenance Procedures & Schedules
Weight & Distribution	▲						Properly Load and Verify Specified Load Limits & Weight Distribution

INDEX

12 Volt System Fuses	7-11
Automotive	7-11
Chassis Alternator	7-12
Interior	7-11

A

ABS plastic	10-10
Appliances	10-9
Propane Gas Appliances & Equipment	10-9
Automatic Hydraulic Power Levelers	4-4
Automatic Leveling & Retraction Procedure	4-5
Emergency Retraction Procedure	4-7
Manual Leveling & Retraction Procedures	4-6
Awnings	5-4
Automatic Patio Awning	5-5
Manual Patio Awning	5-4
Slideout Awning	5-4

B

Batteries	7-3
Battery Charging	7-8
Battery Disconnect Switch	7-7
Battery Isolator Controller (Class A RV)	7-6
Battery Isolator Controller (Class C Mini RV)	7-7
Battery Maintenance	7-4
Battery Safety	7-4
Brakes	3-1

C

Carbon Monoxide & Smoke Detector	2-6
Carbon Monoxide Safety Precautions	2-8
Programming the Alarm	2-6
Testing Procedure	2-7
Ceiling Vents	6-5
Attic Fan	6-6
Exhaust Vent	6-5
Chemical Sensitivity	2-13

Formaldehyde	2-13
Ventilation	2-13

Circuit Breakers	7-11
------------------	------

D

Dash Controls	4-1
ACC (Accessory) Switch	4-1
Driving Lights	4-1
Emergency Start (Optional)	4-1
Fans (Optional)	4-2
Generator Remote Start (Optional)	4-2
Mirror Control Button	4-1
Mirror Heat	4-1
Dash Panel Heater/Air Conditioner	6-1
Air Distribution - Mode Control	6-2
Control Panel	6-1
Operating Features	6-2
Warranty/Service	6-3

Dash Radio	4-2
------------	-----

Disclaimer	1-2
------------	-----

Doors, Drawers & Storage Compartments	4-14
Bed Storage (Some Models)	4-14

Drainage System	10-6
-----------------	------

E

Egress Window	2-16
---------------	------

Electrical System	10-10
-------------------	-------

Emergency Stopping	3-15
--------------------	------

Engine & Drive Train	3-15
Engine Access	3-16
Engine Cooling System	3-15

Entry Door	5-1
------------	-----

Entry Step	5-1	Furniture	4-15
Power Entry Step	5-2	Barrel Chair	4-17
Exterior Lights	10-7	Dinette	4-17
Headlamp Bulb Replacement	10-8	Easy Bed Sofa with Drawer	4-15
Headlamp Condensation	10-7	Euro Recline with Ottoman	4-17
Headlamp Maintenance	10-7	Hide-A-Bed Sofa	4-16
Exterior Paint (Optional)	10-2	Lounge Table	4-17
Precautionary Measures	10-2	Magic Bed Sofa	4-16
Pressure Washing	10-2	Pilot & Co-Pilot Seats	4-18
Extrusions & Aluminum Surfaces	10-4		
		G	
F		Garage Area (Fun Mover)	5-6
Fiberglass Siding	10-1	Core-Trax™ Tie-Down System	5-8
Fire Extinguisher	2-5	Fold-Down Ramp	5-7
Fire Safety	2-4	Liftgate	5-7
Four Winds International Limited Warranty	1		
How to Get Service	2	Generator	7-13
Legal Remedies/Arbitration	4	Ground Fault Circuit Interrupter	7-10
Limitations and Disclaimer of Implied Warranties	1		
Limited Structural Warranty (36 Months/45,000 Miles)	2	I	
What is Covered	1	Introduction	1-1
What is Not Covered	3		
Four Winds Owner's Registration Card	7	L	
Four Winds Owner's Registration Card (Customer)	5	Laws of the Road	2-2
Frame	10-3		
Fresh Water System	8-1	M	
External Hook-up	8-1	Manufacturer's Warranties	1-3
Fresh Water Tank With Gravity Fill	8-2	Mold	10-13
Fresh Water Tank Without Gravity Fill	8-2	Avoid Drastic Thermostat Setbacks	10-15
Sanitizing the Fresh Water System	8-4	Carpet Care & Moisture Management	10-15
Water Pump	8-3	Effects of Prolonged Occupancy10-14	
Fueling the Recreation Vehicle	3-16	Exterior Care of the Recreation Vehicle	10-15
Ford Fuel Pump Collision Shut-off Switch	3-16	How can Mold Growth be Inhibited?	10-13
Furnace	6-4	Storage of the Recreation Vehicle	10-16
		Tips to Controlling Condensation	10-14
		What Factors Contribute to Mold Growth?	10-13
		Monitor Panel	8-5
		Inaccurate Holding Tank Level Readings	8-6
		Oversensitive Readings	8-6
		Technical Support	8-7
		Troubleshooting	8-5
		Under Sensitive Readings	8-7

P		
Periodic Maintenance Chart	10-17
Power Converter	7-8
Power Inverter (Optional)	7-9
Pre-Finished Panels & Wood Surfaces	10-9
Propane Gas Detector	2-9, 9-6
About the Propane Gas Detector	2-11, 9-8
Checking the Propane Gas System for Leaks	9-7
Checking the Propane System for Leaks	2-10
How to Test	2-10, 9-7
Maintenance	2-9, 9-6
Most Common Causes of Apparent Malfunction	2-11, 9-8
Propane Safety Precautions	2-12
Propane Gas Hoses, Pipes Tubes & Fittings	9-5
Propane Gas Safety Precautions	9-9
Propane Gas System	10-5
Propane Gas Tank	9-1
Filling the Tank	9-2
Propane Gas Regulator	9-3
Regulator Freeze-Up	9-4
R		
Rear Ladder/Roof Access	5-3
Rear Vision System	4-3
Recreation Vehicle Load Limits	3-7
Cargo Capacities	3-9
Determining Correct Load Limit	3-10
How Overloading Affects the recreation vehicle & Tires	3-9
Tire Safety Tips	3-10
Weight Label (Example)	3-8
Weight Terms	3-8
RV Serial Number Decal & Data Plates	2-2
Reporting Safety Defects	2-1
Roof	10-4
Roof Mounted Air Conditioner	6-3
Performance Characteristics	6-3
Return Air Filters	6-4
Roof Vents	10-10
S		
Safety for Propane Systems & Appliances	2-3
Seals and Adhesives	10-3
Seat Belts	2-14
Booster Seats	2-15
Child Restraints	2-15
Maintenance	2-14
Seat Belt Operation	2-14
Shore Cord	7-2
30 Amp Shore Power	7-2
50 Amp Shore Power	7-3
Sinks & Countertops	10-8
Slideouts	4-9
Hydraulic Slideout	4-9
Hydraulic Slideout - Manual Retraction	4-10
Non-Hydraulic Slideout	4-12
Non-Hydraulic Slideout - Manual Retraction	4-13
Spare Tire	3-11
Spare Tire Flip Down Style Tire Carrier	3-12
Spare Tire Hoist	3-11
Storage Compartments	5-3
Storage Preparation	10-12
Symbols	2-1

T

Thermostats 6-5

Tires 3-2

- Checking Tire Pressure 3-3
- Recommended Tire Pressure & Load Limits 3-2
- Tire Balance & Wheel Alignment 3-4
- Tire Fundamentals 3-7
- Tire Repair/Replacement 3-6
- Tire Rotation 3-5
- Tire Size 3-3
- Tire Tread 3-4
- Understanding Tire Pressure & Load Limits 3-2
- Wheel Nut Torque 3-6

Tires & Rims 10-4

Towing Procedures 3-14

Trailer Towing 3-13

Travel Preparation 3-17

- Chassis Checks 3-17
- Exterior Checks 3-17
- First Short Trips 3-18
- Operational Checks 3-17

Pre-Trip Checklist 3-18

Undercarriage Checks 3-17

TV Antenna 10-6

Winter Precautions 10-10

- Condensation 10-11
- Food Storage 10-11
- Heating 10-11
- Propane Gas System 10-11
- Water System 10-10

W

Waste Water System 8-7

- Emptying the Holding Tanks 8-9
- Holding Tanks 8-8
- Toilet 8-10

Water System 10-9

Water System Maintenance & Troubleshooting 8-12

Water System Winterization 8-11

- Class A Water System Winterization 8-11
- Class C Water System Winterization 8-12

Windows 4-14

Windows & Doors 10-5



CHATEAU CITATION / DUTCHMEN DORADO / FOUR WINDS SIESTA



CHATEAU / CHATEAU SPORT

DUTCHMEN / DUTCHMEN EXPRESS / FOUR WINDS / FOUR WINDS 5000



FUN MOVER



HURRICANE / MAGELLAN / WINDSPORT

FOUR WINDS INTERNATIONAL

P.O. Box 1486

ELKHART, INDIANA 46515

WWW.FOURWINDS-RV.COM